

Standard Development Timeline

This section is maintained by the drafting team during the development of the standard and will be removed when the standard becomes effective.

Description of Current Draft

On January 21, 2016, the Federal Energy Regulatory Commission (Commission) issued Order No. 822, approving seven Critical Infrastructure Protection (CIP) Reliability Standards and new or modified definitions to be incorporated into the Glossary of Terms Used in NERC Reliability Standards. In addition to approving the seven CIP Reliability Standards, the Commission, directed NERC to, among other things: (1) "...develop modifications to the CIP Reliability Standards to provide mandatory protection for transient devices used at Low Impact BES Cyber Systems...", and (2) modify the definition of LERC.

In response to these directives, NERC first modified Reliability Standard CIP-003-6 to address the LERC directive, which has a regulatory deadline of March 31, 2017 for filing with the Commission. The revisions associated with the LERC directive were developed and posted for comment and ballot in July 2016 in draft Reliability Standard CIP-003-7. The revisions were not approved by stakeholders and based on the feedback received, the drafting team revised its approach and posted the revisions for an additional comment period and ballot. CIP-003-7 passed the additional ballot that ended on December 5, 2016.

For the transient device directive, NERC initially posted draft revisions for an informal comment period from November 1-18, 2016. This draft of Reliability Standard CIP-003-7(i) incorporates the proposed TCA language, as modified based on stakeholder comment, with the recently passed LERC revisions. The intent of this approach is to allow entities time to efficiently plan and implement the required modifications for low impact BES Cyber Systems. The Standard Drafting Team (SDT) approach to address the transient device directive is summarized below.

The SDT revised Attachment 1 of CIP-003-7 to include requirements that mitigate the risk to the BES of malware propagation from transient devices to low impact BES Cyber Systems. Attachment 1 contains and outlines the required sections of a Responsible Entity's cyber security plan(s) for its low impact BES Cyber Systems per Requirement R2. Previously, cyber security plan(s) were required to address four subject matter areas: (1) cyber security awareness; (2) physical security controls; (3) electronic access controls; and (4) Cyber Security Incident response. In keeping with the stakeholder approved approach to incorporate into one standard all the requirements applicable to assets containing low impact BES Cyber Systems, the SDT expanded CIP-003-7 Attachment 1 to include a fifth area: "Transient Cyber Asset and Removable Media Malicious Code Risk Mitigation." Requiring the Responsible Entity to develop and implement these plans will provide higher assurance against the propagation of malware from transient devices.

In addition, the SDT determined it was necessary to revise the definitions of a Transient Cyber Asset (TCA) and Removable Media to ensure applicability of security controls and provide additional clarity. As well, the revised definitions accommodate use of the terms for all impact

levels: high, medium, and low. This is important for those entities that may opt to deploy one program to manage TCAs and Removable Media across multiple impact level assets.

The proposed revised definition of a Transient Cyber Asset (TCA) is:

A Cyber Asset that is:

1. *capable of transmitting or transferring executable code,*
2. *not included in a BES Cyber System,*
3. *not a Protected Cyber Asset (PCA) associated with high or medium impact BES Cyber Systems, and*
4. *directly connected (e.g., using Ethernet, serial, Universal Serial Bus, or wireless including near field or Bluetooth communication) for 30 consecutive calendar days or less to a:*
 - *BES Cyber Asset,*
 - *network within an Electronic Security Perimeter (ESP) containing high or medium impact BES Cyber Systems, or*
 - *PCA associated with high or medium impact BES Cyber Systems.*

Examples of Transient Cyber Assets include, but are not limited to, Cyber Assets used for data transfer, vulnerability assessment, maintenance, or troubleshooting purposes.

The proposed revised definition of Removable Media is:

Storage media that:

1. *are not Cyber Assets,*
2. *are capable of transferring executable code,*
3. *can be used to store, copy, move, or access data, and*
4. *are directly connected for 30 consecutive calendar days or less to a:*
 - *BES Cyber Asset,*
 - *network within an Electronic Service Perimeter (ESP) containing high or medium impact BES Cyber Systems, or*
 - *Protected Cyber Asset associated with high or medium impact BES Cyber Systems.*

Examples of Removable Media include, but are not limited to, floppy disks, compact disks, USB flash drives, external hard drives, and other flash memory cards/drives that contain nonvolatile memory.

As proposed, Section 5 of Attachment 1 of CIP-003-7(i) mandates that entities have malware protection on TCAs (both entity and vendor-managed) and for Removable Media. The SDT proposes that it is necessary to distinguish between the specific protections for: (i) TCAs managed by the Responsible Entity, (ii) TCAs managed by a party other than the Responsible Entity (e.g. vendors or contractors), and (iii) Removable Media.

For TCAs managed by the Responsible Entity, Section 5 requires the Responsible Entity to use one or a combination of the following to mitigate the introduction of malicious code: antivirus software, application whitelisting, or some other method. The SDT recognizes that entities manage these devices in two fundamentally different ways. Some entities maintain a preauthorized inventory of transient devices (i.e., manage in an ongoing manner) while others have a checklist for transient devices prior to connecting them to a BES Cyber System (i.e., manage in an on-demand manner). The SDT acknowledges that both methods are effective and Section 5 permits either form of management. Because of the higher frequency in which these entity-managed devices are used, the controls required for these devices are more specific.

For Transient Cyber Assets managed by a party other than the Responsible Entity, Section 5 requires the Responsible Entity to review and verify the malware mitigation mechanism(s) used by the third party prior to connecting the Transient Cyber Asset (per Transient Cyber Asset capability).

For Removable Media, Section 5 requires entities to employ methods to detect malicious code and mitigate the threat of detected malicious code prior to connecting to a low impact BES Cyber System.

In summary, the SDT made the following changes to address the directive:

1. Revised the definitions of Transient Cyber Asset (TCA) and Removable Media.
2. Revised Requirement R1, by adding Parts 1.2.5 and 1.2.6 to include the complementary policies for the Transient Cyber Assets and Removable Media Malicious Code Risk Mitigation in Requirement R2 (Attachment 1 of CIP-003-7(i)).
3. Revised the requirement language (Requirement R2) in Attachment 1 of CIP-003-7 by adding Section 5 - Transient Cyber Assets and Removable Media Malicious Code Risk Mitigation.
4. Revised the associated VSLs for Requirements R1 and R2 of CIP-003-7.
5. Revised the evidential language of Attachment 2 of CIP-003-7 by adding Section 5 - Transient Cyber Assets and Removable Media Malicious Code Risk Mitigation to complement the revised requirement language.

Completed Actions	Date
Standard Authorization Request approved	July 20, 2016
Draft 1 of CIP-003-7(i) posted for formal comment and initial ballot	December 9, 2016 – January 23, 2017

Anticipated Actions	Date
10-day final ballot	February, 2017
NERC Board of Trustees adoption	February, 2017
Petition filed with FERC	March, 2017

A. Introduction

1. **Title:** Cyber Security — Security Management Controls
2. **Number:** CIP-003-7(i)
3. **Purpose:** To specify consistent and sustainable security management controls that establish responsibility and accountability to protect BES Cyber Systems against compromise that could lead to misoperation or instability in the Bulk Electric System (BES).

4. Applicability:

4.1. Functional Entities: For the purpose of the requirements contained herein, the following list of functional entities will be collectively referred to as “Responsible Entities.” For requirements in this standard where a specific functional entity or subset of functional entities are the applicable entity or entities, the functional entity or entities are specified explicitly.

4.1.1. Balancing Authority

4.1.2. Distribution Provider that owns one or more of the following Facilities, systems, and equipment for the protection or restoration of the BES:

4.1.2.1. Each underfrequency Load shedding (UFLS) or undervoltage Load shedding (UVLS) system that:

4.1.2.1.1. is part of a Load shedding program that is subject to one or more requirements in a NERC or Regional Reliability Standard; and

4.1.2.1.2. performs automatic Load shedding under a common control system owned by the Responsible Entity, without human operator initiation, of 300 MW or more.

4.1.2.2. Each Special Protection System (SPS) or Remedial Action Scheme (RAS) where the SPS or RAS is subject to one or more requirements in a NERC or Regional Reliability Standard.

4.1.2.3. Each Protection System (excluding UFLS and UVLS) that applies to Transmission where the Protection System is subject to one or more requirements in a NERC or Regional Reliability Standard.

4.1.2.4. Each Cranking Path and group of Elements meeting the initial switching requirements from a Blackstart Resource up to and including the first interconnection point of the starting station service of the next generation unit(s) to be started.

4.1.3. Generator Operator

4.1.4. Generator Owner

4.1.5. Interchange Coordinator or Interchange Authority

4.1.6. Reliability Coordinator

4.1.7. Transmission Operator

4.1.8. Transmission Owner

4.2. Facilities: For the purpose of the requirements contained herein, the following Facilities, systems, and equipment owned by each Responsible Entity in Section 4.1 above are those to which these requirements are applicable. For requirements in this standard where a specific type of Facilities, system, or equipment or subset of Facilities, systems, and equipment are applicable, these are specified explicitly.

4.2.1. Distribution Provider: One or more of the following Facilities, systems and equipment owned by the Distribution Provider for the protection or restoration of the BES:

4.2.1.1. Each UFLS or UVLS System that:

4.2.1.1.1. is part of a Load shedding program that is subject to one or more requirements in a NERC or Regional Reliability Standard; and

4.2.1.1.2. performs automatic Load shedding under a common control system owned by the Responsible Entity, without human operator initiation, of 300 MW or more.

4.2.1.2. Each SPS or RAS where the SPS or RAS is subject to one or more requirements in a NERC or Regional Reliability Standard.

4.2.1.3. Each Protection System (excluding UFLS and UVLS) that applies to Transmission where the Protection System is subject to one or more requirements in a NERC or Regional Reliability Standard.

4.2.1.4. Each Cranking Path and group of Elements meeting the initial switching requirements from a Blackstart Resource up to and including the first interconnection point of the starting station service of the next generation unit(s) to be started.

4.2.2. Responsible Entities listed in 4.1 other than Distribution Providers:

All BES Facilities.

4.2.3. Exemptions: The following are exempt from Standard CIP-003-7(i):

4.2.3.1. Cyber Assets at Facilities regulated by the Canadian Nuclear Safety Commission.

4.2.3.2. Cyber Assets associated with communication networks and data communication links between discrete Electronic Security Perimeters (ESPs).

4.2.3.3. The systems, structures, and components that are regulated by the Nuclear Regulatory Commission under a cyber security plan pursuant to 10 C.F.R. Section 73.54.

4.2.3.4. For Distribution Providers, the systems and equipment that are not included in section 4.2.1 above.

5. Effective Dates:

See Implementation Plan for CIP-003-7(i).

6. Background:

Standard CIP-003 exists as part of a suite of CIP Standards related to cyber security, which require the initial identification and categorization of BES Cyber Systems and require organizational, operational, and procedural controls to mitigate risk to BES Cyber Systems.

The term policy refers to one or a collection of written documents that are used to communicate the Responsible Entities' management goals, objectives and expectations for how the Responsible Entity will protect its BES Cyber Systems. The use of policies also establishes an overall governance foundation for creating a culture of security and compliance with laws, regulations, and standards.

The term documented processes refers to a set of required instructions specific to the Responsible Entity and to achieve a specific outcome. This term does not imply any naming or approval structure beyond what is stated in the requirements. An entity should include as much as it believes necessary in its documented processes, but it must address the applicable requirements.

The terms program and plan are sometimes used in place of documented processes where it makes sense and is commonly understood. For example, documented processes describing a response are typically referred to as plans (i.e., incident response plans and recovery plans). Likewise, a security plan can describe an approach involving multiple procedures to address a broad subject matter.

Similarly, the term program may refer to the organization's overall implementation of its policies, plans, and procedures involving a subject matter. Examples in the standards include the personnel risk assessment program and the personnel training program. The full implementation of the CIP Cyber Security Reliability Standards could also be referred to as a program. However, the terms program and plan do not imply any additional requirements beyond what is stated in the standards.

Responsible Entities can implement common controls that meet requirements for multiple high, medium, and low impact BES Cyber Systems. For example, a single cyber security awareness program could meet the requirements across multiple BES Cyber Systems.

Measures provide examples of evidence to show documentation and implementation of the requirement. These measures serve to provide guidance to entities in acceptable records of compliance and should not be viewed as an all-inclusive list.

Throughout the standards, unless otherwise stated, bulleted items in the requirements and measures are items that are linked with an "or," and numbered items are items that are linked with an "and."

Many references in the Applicability section use a threshold of 300 MW for UFLS and UVLS. This particular threshold of 300 MW for UVLS and UFLS was provided in Version 1 of the CIP Cyber Security Standards. The threshold remains at 300 MW since it is specifically addressing UVLS and UFLS, which are last ditch efforts to save the BES. A review of UFLS tolerances defined within Regional Reliability Standards for UFLS program requirements to date indicates that the historical value of 300 MW represents an adequate and reasonable threshold value for allowable UFLS operational tolerances.

B. Requirements and Measures

- R1.** Each Responsible Entity shall review and obtain CIP Senior Manager approval at least once every 15 calendar months for one or more documented cyber security policies that collectively address the following topics: *[Violation Risk Factor: Medium] [Time Horizon: Operations Planning]*
- 1.1.** For its high impact and medium impact BES Cyber Systems, if any:
 - 1.1.1.** Personnel and training (CIP-004);
 - 1.1.2.** Electronic Security Perimeters (CIP-005) including Interactive Remote Access;
 - 1.1.3.** Physical security of BES Cyber Systems (CIP-006);
 - 1.1.4.** System security management (CIP-007);
 - 1.1.5.** Incident reporting and response planning (CIP-008);
 - 1.1.6.** Recovery plans for BES Cyber Systems (CIP-009);
 - 1.1.7.** Configuration change management and vulnerability assessments (CIP-010);
 - 1.1.8.** Information protection (CIP-011); and
 - 1.1.9.** Declaring and responding to CIP Exceptional Circumstances.
 - 1.2.** For its assets identified in CIP-002 containing low impact BES Cyber Systems, if any:
 - 1.2.1.** Cyber security awareness;
 - 1.2.2.** Physical security controls;
 - 1.2.3.** Electronic access controls; ~~and~~
 - 1.2.4.** Cyber Security Incident response;
 - 1.2.5.** Transient Cyber Assets and Removable Media Malicious Code Risk Mitigation;
 - 1.2.6.** Declaring and responding to CIP Exceptional Circumstances
- M1.** Examples of evidence may include, but are not limited to, policy documents; revision history, records of review, or workflow evidence from a document management system that indicate review of each cyber security policy at least once every 15 calendar months; and documented approval by the CIP Senior Manager for each cyber security policy.
- R2.** Each Responsible Entity with at least one asset identified in CIP-002 containing low impact BES Cyber Systems shall implement one or more documented cyber security plan(s) for its low impact BES Cyber Systems that include the sections in Attachment 1. *[Violation Risk Factor: Lower] [Time Horizon: Operations Planning]*

Note: An inventory, list, or discrete identification of low impact BES Cyber Systems or their BES Cyber Assets is not required. Lists of authorized users are not required.

- M2.** Evidence shall include each of the documented cyber security plan(s) that collectively include each of the sections in Attachment 1 and additional evidence to demonstrate implementation of the cyber security plan(s). Additional examples of evidence per section are located in Attachment 2.
- R3.** Each Responsible Entity shall identify a CIP Senior Manager by name and document any change within 30 calendar days of the change. *[Violation Risk Factor: Medium]*
[Time Horizon: Operations Planning]
- M3.** An example of evidence may include, but is not limited to, a dated and approved document from a high level official designating the name of the individual identified as the CIP Senior Manager.
- R4.** The Responsible Entity shall implement a documented process to delegate authority, unless no delegations are used. Where allowed by the CIP Standards, the CIP Senior Manager may delegate authority for specific actions to a delegate or delegates. These delegations shall be documented, including the name or title of the delegate, the specific actions delegated, and the date of the delegation; approved by the CIP Senior Manager; and updated within 30 days of any change to the delegation. Delegation changes do not need to be reinstated with a change to the delegator. *[Violation Risk Factor: Lower]* *[Time Horizon: Operations Planning]*
- M4.** An example of evidence may include, but is not limited to, a dated document, approved by the CIP Senior Manager, listing individuals (by name or title) who are delegated the authority to approve or authorize specifically identified items.

C. Compliance

1. Compliance Monitoring Process

1.1. Compliance Enforcement Authority:

As defined in the NERC Rules of Procedure, “Compliance Enforcement Authority” (CEA) means NERC or the Regional Entity in their respective roles of monitoring and enforcing compliance with the NERC Reliability Standards.

1.2. Evidence Retention:

The following evidence retention periods identify the period of time an entity is required to retain specific evidence to demonstrate compliance. For instances where the evidence retention period specified below is shorter than the time since the last audit, the CEA may ask an entity to provide other evidence to show that it was compliant for the full time period since the last audit.

The Responsible Entity shall keep data or evidence to show compliance as identified below unless directed by its CEA to retain specific evidence for a longer period of time as part of an investigation:

- Each Responsible Entity shall retain evidence of each requirement in this standard for three calendar years.
- If a Responsible Entity is found non-compliant, it shall keep information related to the non-compliance until mitigation is complete and approved or for the time specified above, whichever is longer.
- The CEA shall keep the last audit records and all requested and submitted subsequent audit records.

1.3. Compliance Monitoring and Assessment Processes:

- Compliance Audits
- Self-Certifications
- Spot Checking
- Compliance Investigations
- Self-Reporting
- Complaints

1.4. Additional Compliance Information:

None.

2. Table of Compliance Elements

R #	Time Horizon	VRF	Violation Severity Levels (CIP-003-7(i))			
			Lower VSL	Moderate VSL	High VSL	Severe VSL
R1	Operations Planning	Medium	<p>The Responsible Entity documented and implemented one or more cyber security policies for its high impact and medium impact BES Cyber Systems, but did not address one of the nine topics required by R1. (R1.1)</p> <p>OR</p> <p>The Responsible Entity did not complete its review of the one or more documented cyber security policies for its high impact and medium impact BES Cyber Systems as required by R1 within 15 calendar months but did</p>	<p>The Responsible Entity documented and implemented one or more cyber security policies for its high impact and medium impact BES Cyber Systems, but did not address two of the nine topics required by R1. (R1.1)</p> <p>OR</p> <p>The Responsible Entity did not complete its review of the one or more documented cyber security policies for its high impact and medium impact BES Cyber Systems as required by R1 within 16 calendar months but did</p>	<p>The Responsible Entity documented and implemented one or more cyber security policies for its high impact and medium impact BES Cyber Systems, but did not address three of the nine topics required by R1. (R1.1)</p> <p>OR</p> <p>The Responsible Entity did not complete its review of the one or more documented cyber security policies for its high impact and medium impact BES Cyber Systems as required by R1 within 17 calendar months but did complete this review in less than or equal to 18</p>	<p>The Responsible Entity documented and implemented one or more cyber security policies for its high impact and medium impact BES Cyber Systems, but did not address four or more of the nine topics required by R1. (R1.1)</p> <p>OR</p> <p>The Responsible Entity did not have any documented cyber security policies for its high impact and medium impact BES Cyber Systems as required by R1. (R1.1)</p> <p>OR</p>

R #	Time Horizon	VRF	Violation Severity Levels (CIP-003-7(i))			
			Lower VSL	Moderate VSL	High VSL	Severe VSL
			<p>complete this review in less than or equal to 16 calendar months of the previous review. (R1.1)</p> <p>OR</p> <p>The Responsible Entity did not complete its approval of the one or more documented cyber security policies for its high impact and medium impact BES Cyber Systems as required by R1 by the CIP Senior Manager within 15 calendar months but did complete this approval in less than or equal to 16 calendar months of</p>	<p>complete this review in less than or equal to 17 calendar months of the previous review. (R1.1)</p> <p>OR</p> <p>The Responsible Entity did not complete its approval of the one or more documented cyber security policies for its high impact and medium impact BES Cyber Systems as required by R1 by the CIP Senior Manager within 16 calendar months but did complete this approval in less than or equal to 17 calendar months of</p>	<p>calendar months of the previous review. (R1.1)</p> <p>OR</p> <p>The Responsible Entity did not complete its approval of the one or more documented cyber security policies for its high impact and medium impact BES Cyber Systems as required by R1 by the CIP Senior Manager within 17 calendar months but did complete this approval in less than or equal to 18 calendar months of the previous approval. (R1)</p> <p>OR</p> <p>The Responsible Entity documented one or more cyber security policies for its assets identified in CIP-002 containing low impact</p>	<p>The Responsible Entity did not complete its review of the one or more documented cyber security policies as required by R1 within 18 calendar months of the previous review. (R1)</p> <p>OR</p> <p>The Responsible Entity did not complete its approval of the one or more documented cyber security policies for its high impact and medium impact BES Cyber Systems as required by R1 by the CIP Senior Manager within 18 calendar months of</p>

R #	Time Horizon	VRF	Violation Severity Levels (CIP-003-7(i))			
			Lower VSL	Moderate VSL	High VSL	Severe VSL
			<p>the previous approval. (R1.1)</p> <p>OR</p> <p>The Responsible Entity documented one or more cyber security policies for its assets identified in CIP-002 containing low impact BES Cyber Systems, but did not address one of the four topics required by R1. (R1.2)</p> <p>OR</p> <p>The Responsible Entity did not complete its review of the one or more documented cyber security policies for its assets identified in CIP-002 containing low impact BES Cyber Systems as</p>	<p>the previous approval. (R1.1)</p> <p>OR</p> <p>The Responsible Entity documented one or more cyber security policies for its assets identified in CIP-002 containing low impact BES Cyber Systems, but did not address two of the four topics required by R1. (R1.2)</p> <p>OR</p> <p>The Responsible Entity did not complete its review of the one or more documented cyber security policies for its assets identified in CIP-002 containing low impact BES Cyber Systems as</p>	<p>BES Cyber Systems, but did not address three of the four topics required by R1. (R1.2)</p> <p>OR</p> <p>The Responsible Entity did not complete its review of the one or more documented cyber security policies for its assets identified in CIP-002 containing low impact BES Cyber Systems as required by R1 within 17 calendar months but did complete this review in less than or equal to 18 calendar months of the previous review. (R1.2)</p> <p>OR</p> <p>The Responsible Entity did not complete its approval of the one or more documented cyber security policies for its</p>	<p>the previous approval. (R1.1)</p> <p>OR</p> <p>The Responsible Entity documented one or more cyber security policies for its assets identified in CIP-002 containing low impact BES Cyber Systems, but did not address any four or more of the four topics required by R1. (R1.2)</p> <p>OR</p> <p>The Responsible Entity did not have any documented cyber security policies for its assets identified in CIP-002 containing low impact BES Cyber</p>

R #	Time Horizon	VRF	Violation Severity Levels (CIP-003-7(i))			
			Lower VSL	Moderate VSL	High VSL	Severe VSL
			<p>required by Requirement R1 within 15 calendar months but did not complete this review in less than or equal to 16 calendar months of the previous review. (R1.2)</p> <p>OR</p> <p>The Responsible Entity did not complete its approval of the one or more documented cyber security policies for its assets identified in CIP-002 containing low impact BES Cyber Systems as required by Requirement R1 by the CIP Senior Manager within 15 calendar months but did not complete this</p>	<p>required by Requirement R1 within 16 calendar months but did not complete this review in less than or equal to 17 calendar months of the previous review. (R1.2)</p> <p>OR</p> <p>The Responsible Entity did not complete its approval of the one or more documented cyber security policies for its assets identified in CIP-002 containing low impact BES Cyber Systems as required by Requirement R1 by the CIP Senior Manager within 16 calendar months but</p>	<p>assets identified in CIP-002 containing low impact BES Cyber Systems as required by Requirement R1 by the CIP Senior Manager within 17 calendar months but did not complete this approval in less than or equal to 18 calendar months of the previous approval. (R1.2)</p>	<p>Systems as required by R1. (R1.2)</p> <p>OR</p> <p>The Responsible Entity did not complete its approval of the one or more documented cyber security policies for its assets identified in CIP-002 containing low impact BES Cyber Systems as required by Requirement R1 by the CIP Senior Manager within 18 calendar months of the previous approval. (R1.2)</p>

R #	Time Horizon	VRF	Violation Severity Levels (CIP-003-7(i))			
			Lower VSL	Moderate VSL	High VSL	Severe VSL
			approval in less than or equal to 16 calendar months of the previous approval. (R1.2)	did complete this approval in less than or equal to 17 calendar months of the previous approval. (R1.2)		
R2	Operations Planning	Lower	<p>The Responsible Entity documented its cyber security plan(s) for its assets containing low impact BES Cyber Systems, but failed to document cyber security awareness according to Requirement R2, Attachment 1, Section 1. (R2)</p> <p>OR</p> <p>The Responsible Entity implemented electronic access controls but failed to document its cyber security plan(s) for</p>	<p>The Responsible Entity documented its cyber security plan(s) for its assets containing low impact BES Cyber Systems, but failed to reinforce cyber security practices at least once every 15 calendar months according to Requirement R2, Attachment 1, Section 1. (R2)</p> <p>OR</p> <p>The Responsible Entity documented its cyber security plan(s) for its assets</p>	<p>The Responsible Entity documented the physical access controls for its assets containing low impact BES Cyber Systems, but failed to implement the physical security controls according to Requirement R2, Attachment 1, Section 2. (R2)</p> <p>OR</p> <p>The Responsible Entity documented its cyber security plan(s) for electronic access controls for its assets containing low impact BES Cyber Systems, but</p>	<p>The Responsible Entity failed to document and implement one or more cyber security plan(s) for its assets containing low impact BES Cyber Systems according to Requirement R2, Attachment 1. (R2)</p>

R #	Time Horizon	VRF	Violation Severity Levels (CIP-003-7(i))			
			Lower VSL	Moderate VSL	High VSL	Severe VSL
			electronic access controls according to Requirement R2, Attachment 1, Section 3. (R2) OR The Responsible Entity documented its cyber security plan(s) for its assets containing low impact BES Cyber Systems, but failed to document one or more Cyber Security Incident response plan(s) according to Requirement R2, Attachment 1, Section 4. (R2) OR The Responsible Entity documented one or more Cyber Security Incident response plan(s)	containing low impact BES Cyber Systems, but failed to document physical security controls according to Requirement R2, Attachment 1, Section 2. (R2) OR The Responsible Entity documented its cyber security plan(s) for its assets containing low impact BES Cyber Systems, but failed to document electronic access controls according to Requirement R2, Attachment 1, Section 3. (R2) OR The Responsible Entity documented	failed to permit only necessary inbound and outbound electronic access controls according to Requirement R2, Attachment 1, Section 3.1. (R2) OR The Responsible Entity documented one or more Cyber Security Incident response plan(s) within its cyber security plan(s) for its assets containing low impact BES Cyber Systems, but failed to test each Cyber Security Incident response plan(s) at least once every 36 calendar months according to Requirement R2, Attachment 1, Section 4. (R2) OR	

R #	Time Horizon	VRF	Violation Severity Levels (CIP-003-7(i))			
			Lower VSL	Moderate VSL	High VSL	Severe VSL
			<p>within its cyber security plan(s) for its assets containing low impact BES Cyber Systems, but failed to update each Cyber Security Incident response plan(s) within 180 days according to Requirement R2, Attachment 1, Section 4. (R2)</p> <p><u>OR</u></p> <p><u>The Responsible Entity documented its plan(s) for Transient Cyber Assets and Removable Media, but failed to manage its Transient Cyber Asset(s) according to Requirement R2, Attachment 1, Section 5.1. (R2)</u></p>	<p>its cyber security plan(s) for electronic access controls but failed to implement authentication for all Dial-up Connectivity that provides access to low impact BES Cyber System(s), per Cyber Asset capability according to Requirement R2, Attachment 1, Section 3.2 (R2)</p> <p>OR</p> <p>The Responsible Entity documented one or more incident response plan(s) within its cyber security plan(s) for its assets containing low impact BES Cyber Systems, but failed to include the process for identification,</p>	<p>The Responsible Entity documented the determination of whether an identified Cyber Security Incident is a Reportable Cyber Security Incident, but failed to notify the Electricity Information Sharing and Analysis Center (E-ISAC) according to Requirement R2, Attachment 1, Section 4. (R2)</p> <p><u>OR</u></p> <p><u>The Responsible Entity documented its plan(s) for Transient Cyber Assets and Removable Media, but failed to implement mitigation for the introduction of malicious code for Transient Cyber Assets managed by the Responsible Entity</u></p>	

R #	Time Horizon	VRF	Violation Severity Levels (CIP-003-7(i))			
			Lower VSL	Moderate VSL	High VSL	Severe VSL
			<p><u>OR</u></p> <p><u>The Responsible Entity documented its plan(s) for Transient Cyber Assets and Removable Media, but failed to document the Removable Media section(s) according to Requirement R2, Attachment 1, Section 5.3. (R2)</u></p>	<p>classification, and response to Cyber Security Incidents according to Requirement R2, Attachment 1, Section 4. (R2)</p> <p>OR</p> <p>The Responsible Entity documented its cyber security plan(s) for its assets containing low impact BES Cyber Systems, but failed to document the determination of whether an identified Cyber Security Incident is a Reportable Cyber Security Incident and subsequent notification to the Electricity Information Sharing and Analysis Center</p>	<p><u>according to Requirement R2, Attachment 1, Section 5.1. (R2)</u></p> <p><u>OR</u></p> <p><u>The Responsible Entity documented its plan(s) for Transient Cyber Assets and Removable Media, but failed to implement mitigation for the introduction of malicious code for Transient Cyber Assets managed by a party other than the Responsible Entity according to Requirement R2, Attachment 1, Section 5.2. (R2)</u></p> <p><u>OR</u></p> <p><u>The Responsible Entity documented its plan(s) for Transient Cyber Assets and Removable</u></p>	

R #	Time Horizon	VRF	Violation Severity Levels (CIP-003-7(i))			
			Lower VSL	Moderate VSL	High VSL	Severe VSL
				<p>(E-ISAC) according to Requirement R2, Attachment 1, Section 4. (R2)</p> <p><u>OR</u></p> <p><u>The Responsible Entity documented its plan(s) for Transient Cyber Assets and Removable Media, but failed to document mitigation for the introduction of malicious code for Transient Cyber Assets managed by the Responsible Entity according to Requirement R2, Attachment 1, Sections 5.1 and 5.3. (R2)</u></p> <p><u>OR</u></p> <p><u>The Responsible Entity documented</u></p>	<p><u>Media, but failed to implement mitigation for the threat of detected malicious code on the Removable Media prior to connecting Removable Media to a low impact BES Cyber System according to Requirement R2, Attachment 1, Section 5.3. (R2)</u></p>	

R #	Time Horizon	VRF	Violation Severity Levels (CIP-003-7(i))			
			Lower VSL	Moderate VSL	High VSL	Severe VSL
				<p><u>its plan(s) for Transient Cyber Assets and Removable Media, but failed to document mitigation for the introduction of malicious code for Transient Cyber Assets managed by a party other than the Responsible Entity according to Requirement R2, Attachment 1, Section 5.2. (R2)</u></p> <p><u>OR</u></p> <p><u>The Responsible Entity documented its plan(s) for Transient Cyber Assets and Removable Media, but failed to implement the Removable Media section(s) according</u></p>		

R #	Time Horizon	VRF	Violation Severity Levels (CIP-003-7(i))			
			Lower VSL	Moderate VSL	High VSL	Severe VSL
				<u>to Requirement R2, Attachment 1, Section 5.3. (R2)</u>		
R3	Operations Planning	Medium	The Responsible Entity has identified by name a CIP Senior Manager, but did not document changes to the CIP Senior Manager within 30 calendar days but did document this change in less than 40 calendar days of the change. (R3)	The Responsible Entity has identified by name a CIP Senior Manager, but did not document changes to the CIP Senior Manager within 40 calendar days but did document this change in less than 50 calendar days of the change. (R3)	The Responsible Entity has identified by name a CIP Senior Manager, but did not document changes to the CIP Senior Manager within 50 calendar days but did document this change in less than 60 calendar days of the change. (R3)	The Responsible Entity has not identified, by name, a CIP Senior Manager. OR The Responsible Entity has identified by name a CIP Senior Manager, but did not document changes to the CIP Senior Manager within 60 calendar days of the change. (R3)
R4	Operations Planning	Lower	The Responsible Entity has identified a delegate by name, title, date of delegation, and specific actions	The Responsible Entity has identified a delegate by name, title, date of delegation, and specific actions	The Responsible Entity has identified a delegate by name, title, date of delegation, and specific actions delegated, but did not document	The Responsible Entity has used delegated authority for actions where allowed by the CIP Standards, but does

R #	Time Horizon	VRF	Violation Severity Levels (CIP-003-7(i))			
			Lower VSL	Moderate VSL	High VSL	Severe VSL
			delegated, but did not document changes to the delegate within 30 calendar days but did document this change in less than 40 calendar days of the change. (R4)	delegated, but did not document changes to the delegate within 40 calendar days but did document this change in less than 50 calendar days of the change. (R4)	changes to the delegate within 50 calendar days but did document this change in less than 60 calendar days of the change. (R4)	not have a process to delegate actions from the CIP Senior Manager. (R4) OR The Responsible Entity has identified a delegate by name, title, date of delegation, and specific actions delegated, but did not document changes to the delegate within 60 calendar days of the change. (R4)

D. Regional Variances

None.

E. Interpretations

None.

F. Associated Documents

None.

Version History

Version	Date	Action	Change Tracking
1	1/16/06	R3.2 — Change “Control Center” to “control center.”	3/24/06
2	9/30/09	<p>Modifications to clarify the requirements and to bring the compliance elements into conformance with the latest guidelines for developing compliance elements of standards.</p> <p>Removal of reasonable business judgment.</p> <p>Replaced the RRO with the RE as a responsible entity.</p> <p>Rewording of Effective Date.</p> <p>Changed compliance monitor to Compliance Enforcement Authority.</p>	
3	12/16/09	<p>Updated Version Number from -2 to -3</p> <p>In Requirement 1.6, deleted the sentence pertaining to removing component or system from service in order to perform testing, in response to FERC order issued September 30, 2009.</p>	
3	12/16/09	Approved by the NERC Board of Trustees.	

Version	Date	Action	Change Tracking
3	3/31/10	Approved by FERC.	
4	1/24/11	Approved by the NERC Board of Trustees.	
5	11/26/12	Adopted by the NERC Board of Trustees.	Modified to coordinate with other CIP standards and to revise format to use RBS Template.
5	11/22/13	FERC Order issued approving CIP-003-5.	
6	11/13/14	Adopted by the NERC Board of Trustees.	Addressed two FERC directives from Order No. 791 related to identify, assess, and correct language and communication networks.
6	2/12/15	Adopted by the NERC Board of Trustees.	Replaces the version adopted by the Board on 11/13/2014. Revised version

Version	Date	Action	Change Tracking
			addresses remaining directives from Order No. 791 related to transient devices and low impact BES Cyber Systems.
6	1/21/16	FERC Order issued approving CIP-003-6. Docket No. RM15-14-000	
7(i)	TBD	Adopted by the NERC Board of Trustees.	Revised to address FERC Order <u>No. 822</u> directives <u>directives</u> regarding <u>(1) the definition of LERC</u> and <u>(2) transient devices</u> .

Attachment 1

Required Sections for Cyber Security Plan(s) for Assets Containing Low Impact BES Cyber Systems

Responsible Entities shall include each of the sections provided below in the cyber security plan(s) required under Requirement R2.

Responsible Entities with multiple-impact BES Cyber Systems ratings can utilize policies, procedures, and processes for their high or medium impact BES Cyber Systems to fulfill the sections for the development of low impact cyber security plan(s). Each Responsible Entity can develop a cyber security plan(s) either by individual asset or groups of assets.

Section 1. Cyber Security Awareness: Each Responsible Entity shall reinforce, at least once every 15 calendar months, cyber security practices (which may include associated physical security practices).

Rationale for Modifications to Sections 2 and 3 of Attachment 1 (Requirement R2):

Requirement R2 mandates that entities develop and implement one or more cyber security plan(s) to meet specific security objectives for assets containing low impact BES Cyber System(s). In Paragraph 73 of FERC Order No. 822, the Commission directed NERC to modify "...the Low Impact External Routable Connectivity definition to reflect the commentary in the Guidelines and Technical Basis section of CIP-003-6...to provide needed clarity to the definition and eliminate ambiguity surrounding the term 'direct' as it is used in the proposed definition...within one year of the effective date of this Final Rule."

The revisions to Section 3 incorporate select language from the LERC definition into Attachment 1 and focus the requirement on implementing electronic access controls for asset(s) containing low impact BES Cyber System(s). This change requires the Responsible Entity to permit only necessary inbound and outbound electronic access when using a routable protocol entering or leaving the asset between low impact BES Cyber System(s) and a Cyber Asset(s) outside the asset containing low impact BES Cyber system(s). When this communication is present, Responsible Entities are required to implement electronic access controls unless that communication meets the following exclusion language (previously in the definition of LERC) contained in romanette (iii): "not used for time-sensitive protection or control functions between intelligent electronic devices (e.g. communications using protocol IEC TR-61850-90-5 R-GOOSE)".

The revisions to Section 2 of Attachment 1 complement the revisions to Section 3; consequently, the requirement now mandates the Responsible Entity control physical access to "the Cyber Asset(s), as specified by the Responsible Entity, that provide electronic access control(s) implemented for Section 3.1, if any." The

focus on electronic access controls rather than on the Low Impact BES Cyber System Electronic Access Points (LEAPs) eliminates the need for LEAPs.

Given these revisions to Sections 2 and 3, the NERC Glossary terms: Low Impact External Routable Connectivity (LERC) and Low Impact BES Cyber System Electronic Access Point (LEAP) will be retired.

Section 2. Physical Security Controls: Each Responsible Entity shall control physical access, based on need as determined by the Responsible Entity, to (1) the asset or the locations of the low impact BES Cyber Systems within the asset, and (2) the Cyber Asset(s), as specified by the Responsible Entity, that provide electronic access control(s) implemented for Section 3.1, if any.

Section 3. Electronic Access Controls: For each asset containing low impact BES Cyber System(s) identified pursuant to CIP-002, the Responsible Entity shall implement electronic access controls to:

- 3.1** Permit only necessary inbound and outbound electronic access as determined by the Responsible Entity for any communications that are:
 - i. between a low impact BES Cyber System(s) and a Cyber Asset(s) outside the asset containing low impact BES Cyber System(s);
 - ii. using a routable protocol when entering or leaving the asset containing the low impact BES Cyber System(s); and
 - iii. not used for time-sensitive protection or control functions between intelligent electronic devices (e.g., communications using protocol IEC TR-61850-90-5 R-GOOSE).
- 3.2** Authenticate all Dial-up Connectivity, if any, that provides access to low impact BES Cyber System(s), per Cyber Asset capability.

Section 4. Cyber Security Incident Response: Each Responsible Entity shall have one or more Cyber Security Incident response plan(s), either by asset or group of assets, which shall include:

- 4.1** Identification, classification, and response to Cyber Security Incidents;
- 4.2** Determination of whether an identified Cyber Security Incident is a Reportable Cyber Security Incident and subsequent notification to the Electricity Information Sharing and Analysis Center (E-ISAC), unless prohibited by law;
- 4.3** Identification of the roles and responsibilities for Cyber Security Incident response by groups or individuals;
- 4.4** Incident handling for Cyber Security Incidents;
- 4.5** Testing the Cyber Security Incident response plan(s) at least once every 36 calendar months by: (1) responding to an actual Reportable Cyber Security

Incident; (2) using a drill or tabletop exercise of a Reportable Cyber Security Incident; or (3) using an operational exercise of a Reportable Cyber Security Incident; and

- 4.6 Updating the Cyber Security Incident response plan(s), if needed, within 180 calendar days after completion of a Cyber Security Incident response plan(s) test or actual Reportable Cyber Security Incident.

Rationale for Section 5 of Attachment 1 (Requirement R2):

Requirement R2 mandates that entities develop and implement one or more cyber security plan(s) to meet specific security objectives for assets containing low impact BES Cyber System(s). In Paragraph 32 of FERC Order No. 822, the Commission directed NERC to “...provide mandatory protection for transient devices used at Low Impact BES Cyber Systems based on the risk posed to bulk electric system reliability.” Transient devices are potential vehicles for introducing malicious code into low impact BES Cyber Systems. Section 5 of Attachment 1 is intended to mitigate the risk of malware propagation to the BES through low impact BES Cyber Systems by requiring entities to develop and implement one or more plan(s) to address the risk. The cyber security plan(s) along with the cyber security policies required under Requirement R1, Part 1.2, provide a framework for operational, procedural, and technical safeguards for low impact BES Cyber Systems.

Section 5. Transient Cyber Asset and Removable Media Malicious Code Risk Mitigation: Each Responsible Entity shall implement, except under CIP Exceptional Circumstances, one or more plan(s) to achieve the objective of mitigating the risk of the introduction of malicious code to low impact BES Cyber Systems through the use of Transient Cyber Assets or Removable Media. The plan(s) shall include:

- 5.1 For Transient Cyber Asset(s) managed by the Responsible Entity, if any, the use of one or a combination of the following in an ongoing or on-demand manner (per Transient Cyber Asset capability):**
- Antivirus software, including manual or managed updates of signatures or patterns;
 - Application whitelisting; or
 - Other method(s) to mitigate the introduction of malicious code.
- 5.2 For Transient Cyber Asset(s) managed by a party other than the Responsible Entity, if any, the use of one or a combination of the following prior to connecting the Transient Cyber Asset to a low impact BES Cyber System (per Transient Cyber Asset capability):**
- Review of antivirus update level;
 - Review of antivirus update process used by the party;

- Review of application whitelisting used by the party;
- Review use of live operating system and software executable only from read-only media;
- Review of system hardening used by the party; or
- Other method(s) to mitigate the introduction of malicious code.

5.3 For Removable Media, the use of each of the following:

5.3.1 Method(s) to detect malicious code on Removable Media using a Cyber Asset other than a BES Cyber System; and

5.3.2 Mitigation of the threat of detected malicious code on the Removable Media prior to connecting Removable Media to a low impact BES Cyber System.

Attachment 2

Examples of Evidence for Cyber Security Plan(s) for Assets Containing Low Impact BES Cyber Systems

Section 1. Cyber Security Awareness: An example of evidence for Section 1 may include, but is not limited to, documentation that the reinforcement of cyber security practices occurred at least once every 15 calendar months. The evidence could be documentation through one or more of the following methods:

- Direct communications (for example, e-mails, memos, or computer-based training);
- Indirect communications (for example, posters, intranet, or brochures); or
- Management support and reinforcement (for example, presentations or meetings).

Section 2. Physical Security Controls: Examples of evidence for Section 2 may include, but are not limited to:

- Documentation of the selected access control(s) (e.g., card key, locks, perimeter controls), monitoring controls (e.g., alarm systems, human observation), or other operational, procedural, or technical physical security controls that control physical access to both:
 - a. The asset, if any, or the locations of the low impact BES Cyber Systems within the asset; and
 - b. The Cyber Asset(s) specified by the Responsible Entity that provide(s) electronic access controls implemented for Attachment 1, Section 3.1, if any.

Section 3. Electronic Access Controls: Examples of evidence for Section 3 may include, but are not limited to:

1. Documentation showing that at each asset or group of assets containing low impact BES Cyber Systems, routable communication between a low impact BES Cyber System(s) and a Cyber Asset(s) outside the asset is restricted by electronic access controls to permit only inbound and outbound electronic access that the Responsible Entity deems necessary, except where an entity provides rationale that communication is used for time-sensitive protection or control functions between intelligent electronic devices. Examples of such documentation may include, but are not limited to representative diagrams that illustrate control of inbound and outbound communication(s) between the low impact BES Cyber System(s) and a Cyber Asset(s) outside the asset containing low impact BES Cyber System(s) or lists of implemented electronic access controls (e.g., access control lists restricting IP addresses, ports, or services; implementing unidirectional gateways).

2. Documentation of authentication for Dial-up Connectivity (e.g., dial out only to a preprogrammed number to deliver data, dial-back modems, modems that must be remotely controlled by the control center or control room, or access control on the BES Cyber System).

Section 4. Cyber Security Incident Response: An example of evidence for Section 4 may include, but is not limited to, dated documentation, such as policies, procedures, or process documents of one or more Cyber Security Incident response plan(s) developed either by asset or group of assets that include the following processes:

1. to identify, classify, and respond to Cyber Security Incidents; to determine whether an identified Cyber Security Incident is a Reportable Cyber Security Incident and for notifying the Electricity Information Sharing and Analysis Center (E-ISAC);
2. to identify and document the roles and responsibilities for Cyber Security Incident response by groups or individuals (e.g., initiating, documenting, monitoring, reporting, etc.);
3. for incident handling of a Cyber Security Incident (e.g., containment, eradication, or recovery/incident resolution);
4. for testing the plan(s) along with the dated documentation that a test has been completed at least once every 36 calendar months; and
5. to update, as needed, Cyber Security Incident response plan(s) within 180 calendar days after completion of a test or actual Reportable Cyber Security Incident.

Section 5. Transient Cyber Asset and Removable Media Malicious Code Risk Mitigation:

1. Examples of evidence for Section 5.1 may include, but are not limited to, documentation of the method(s) used to mitigate the introduction of malicious code such as antivirus software and processes for managing signature or pattern updates, application whitelisting practices, processes to restrict communication, or other method(s) to mitigate the introduction of malicious code. If a Transient Cyber Asset does not have the capability to use method(s) that mitigate the introduction of malicious code, evidence may include documentation by the vendor or Responsible Entity that identifies that the Transient Cyber Asset does not have the capability.
2. Examples of evidence for Section 5.2 may include, but are not limited to, documentation from change management systems, electronic mail or procedures that document a review of the installed antivirus update level; memoranda, electronic mail, system documentation, policies or contracts from the party other than the Responsible Entity that identify the antivirus update process, the use of application whitelisting, use of live operating systems or system hardening performed by the party other than the Responsible Entity;

evidence from change management systems, electronic mail or contracts that identifies the Responsible Entity's acceptance that the practices of the party other than the Responsible Entity are acceptable; or documentation of other method(s) to mitigate malicious code for Transient Cyber Asset(s) managed by a party other than the Responsible Entity. If a Transient Cyber Asset does not have the capability to use method(s) that mitigate the introduction of malicious code, evidence may include documentation by the Responsible Entity or the party other than the Responsible Entity that identifies that the Transient Cyber Asset does not have the capability

3. Examples of evidence for Section 5.3.1 may include, but are not limited to, documented process(es) of the method(s) used to detect malicious code such as results of scan settings for Removable Media, or implementation of on-demand scanning. Examples of evidence for Section 5.3.2 may include, but are not limited to, documented process(es) for the method(s) used for mitigating the threat of detected malicious code on Removable Media, such as logs from the method(s) used to detect malicious code that show the results of scanning and the mitigation of detected malicious code on Removable Media or documented confirmation by the entity that the Removable Media was deemed to be free of malicious code.

Guidelines and Technical Basis

Section 4 – Scope of Applicability of the CIP Cyber Security Standards

Section “4. Applicability” of the standards provides important information for Responsible Entities to determine the scope of the applicability of the CIP Cyber Security Requirements.

Section “4.1. Functional Entities” is a list of NERC functional entities to which the standard applies. If the entity is registered as one or more of the functional entities listed in Section 4.1, then the NERC CIP Cyber Security Standards apply. Note that there is a qualification in Section 4.1 that restricts the applicability in the case of Distribution Providers to only those that own certain types of systems and equipment listed in 4.2.

Section “4.2. Facilities” defines the scope of the Facilities, systems, and equipment owned by the Responsible Entity, as qualified in Section 4.1, that is subject to the requirements of the standard. In addition to the set of BES Facilities, Control Centers, and other systems and equipment, the list includes the set of systems and equipment owned by Distribution Providers. While the NERC Glossary term “Facilities” already includes the BES characteristic, the additional use of the term BES here is meant to reinforce the scope of applicability of these Facilities where it is used, especially in this applicability scoping section. This in effect sets the scope of Facilities, systems, and equipment that is subject to the standards.

Requirement R1:

In developing policies in compliance with Requirement R1, the number of policies and their content should be guided by a Responsible Entity's management structure and operating conditions. Policies might be included as part of a general information security program for the entire organization, or as components of specific programs. The Responsible Entity has the flexibility to develop a single comprehensive cyber security policy covering the required topics, or it may choose to develop a single high-level umbrella policy and provide additional policy detail in lower level documents in its documentation hierarchy. In the case of a high-level umbrella policy, the Responsible Entity would be expected to provide the high-level policy as well as the additional documentation in order to demonstrate compliance with CIP-003-7, Requirement R1.

If a Responsible Entity has any high or medium impact BES Cyber Systems, the one or more cyber security policies must cover the nine subject matter areas required by CIP-003-7, Requirement R1, Part 1.1. If a Responsible Entity has identified from CIP-002 any assets containing low impact BES Cyber Systems, the one or more cyber security policies must cover the ~~four~~six subject matter areas required by Requirement R1, Part 1.2.

Responsible Entities that have multiple-impact rated BES Cyber Systems are not required to create separate cyber security policies for high, medium, or low impact BES Cyber Systems. The Responsible Entities have the flexibility to develop policies that cover all three impact ratings.

Implementation of the cyber security policy is not specifically included in CIP-003-7, Requirement R1 as it is envisioned that the implementation of this policy is evidenced through successful implementation of CIP-003 through CIP-011. However, Responsible Entities are encouraged not to limit the scope of their cyber security policies to only those requirements in NERC cyber security Reliability Standards, but to develop a holistic cyber security policy

appropriate for its organization. Elements of a policy that extend beyond the scope of NERC's cyber security Reliability Standards will not be considered candidates for potential violations although they will help demonstrate the organization's internal culture of compliance and posture towards cyber security.

For Part 1.1, the Responsible Entity should consider the following for each of the required topics in its one or more cyber security policies for medium and high impact BES Cyber Systems, if any:

1.1.1 Personnel and training (CIP-004)

- Organization position on acceptable background investigations
- Identification of possible disciplinary action for violating this policy
- Account management

1.1.2 Electronic Security Perimeters (CIP-005) including Interactive Remote Access

- Organization stance on use of wireless networks
- Identification of acceptable authentication methods
- Identification of trusted and untrusted resources
- Monitoring and logging of ingress and egress at Electronic Access Points
- Maintaining up-to-date anti-malware software before initiating Interactive Remote Access
- Maintaining up-to-date patch levels for operating systems and applications used to initiate Interactive Remote Access
- Disabling VPN "split-tunneling" or "dual-homed" workstations before initiating Interactive Remote Access
- For vendors, contractors, or consultants: include language in contracts that requires adherence to the Responsible Entity's Interactive Remote Access controls

1.1.3 Physical security of BES Cyber Systems (CIP-006)

- Strategy for protecting Cyber Assets from unauthorized physical access
- Acceptable physical access control methods
- Monitoring and logging of physical ingress

1.1.4 System security management (CIP-007)

- Strategies for system hardening
- Acceptable methods of authentication and access control
- Password policies including length, complexity, enforcement, prevention of brute force attempts
- Monitoring and logging of BES Cyber Systems

- 1.1.5 Incident reporting and response planning (CIP-008)
 - Recognition of Cyber Security Incidents
 - Appropriate notifications upon discovery of an incident
 - Obligations to report Cyber Security Incidents
- 1.1.6 Recovery plans for BES Cyber Systems (CIP-009)
 - Availability of spare components
 - Availability of system backups
- 1.1.7 Configuration change management and vulnerability assessments (CIP-010)
 - Initiation of change requests
 - Approval of changes
 - Break-fix processes
- 1.1.8 Information protection (CIP-011)
 - Information access control methods
 - Notification of unauthorized information disclosure
 - Information access on a need-to-know basis
- 1.1.9 Declaring and responding to CIP Exceptional Circumstances
 - Processes to invoke special procedures in the event of a CIP Exceptional Circumstance
 - Processes to allow for exceptions to policy that do not violate CIP requirements

Requirements relating to exceptions to a Responsible Entity's security policies were removed because it is a general management issue that is not within the scope of a reliability requirement. It is an internal policy requirement and not a reliability requirement. However, Responsible Entities are encouraged to continue this practice as a component of their cyber security policies.

In this and all subsequent required approvals in the NERC CIP Reliability Standards, the Responsible Entity may elect to use hardcopy or electronic approvals to the extent that there is sufficient evidence to ensure the authenticity of the approving party.

Requirement R2:

The intent of Requirement R2 is for each Responsible Entity to create, document, and implement one or more cyber security plan(s) that address the security objective for the protection of low impact BES Cyber Systems. The required protections are designed to be part of a program that covers the low impact BES Cyber Systems collectively at an asset level (based on the list of assets containing low impact BES Cyber Systems identified in CIP-002), but not at an individual device or system level.

Requirement R2, Attachment 1

As noted, Attachment 1 contains the sections that must be included in the cyber security plan(s). The intent is to allow entities that have a combination of high, medium, and low impact BES Cyber Systems the flexibility to choose, if desired, to cover their low impact BES Cyber Systems (or any subset) under their programs used for the high or medium impact BES Cyber Systems rather than maintain two separate programs. The purpose of the cyber security plan(s) in Requirement R2 is for Responsible Entities to use the cyber security plan(s) as a means of documenting their approaches to meeting the subject matter areas. The cyber security plan(s) can be used to reference other policies and procedures that demonstrate “how” the Responsible Entity is meeting each of the subject matter areas, or Responsible Entities can develop comprehensive cyber security plan(s) that contain all of the detailed implementation content solely within the cyber security plan itself. To meet the obligation for the cyber security plan, the expectation is that the cyber security plan contains or references sufficient details to address the implementation of each of the required subject matters areas.

Guidance for each of the subject matter areas of Attachment 1 is provided below.

Requirement R2, Attachment 1, Section 1 – Cyber Security Awareness

The intent of the cyber security awareness program is for entities to reinforce good cyber security practices with their personnel at least once every 15 calendar months. The entity has the discretion to determine the topics to be addressed and the manner in which it will communicate these topics. As evidence of compliance, the Responsible Entity should be able to produce the awareness material that was delivered according to the delivery method(s) (e.g., posters, emails, or topics at staff meetings, etc.). The standard drafting team does not intend for Responsible Entities to be required to maintain lists of recipients and track the reception of the awareness material by personnel.

Although the focus of the awareness is cyber security, it does not mean that only technology-related topics can be included in the program. Appropriate physical security topics (e.g., tailgating awareness and protection of badges for physical security, or “If you see something, say something” campaigns, etc.) are valid for cyber security awareness. The intent is to cover topics concerning any aspect of the protection of BES Cyber Systems.

Requirement R2, Attachment 1, Section 2 – Physical Security Controls

The Responsible Entity must document and implement methods to control physical access to (1) the asset or the locations of low impact BES Cyber Systems within the asset, and (2) Cyber Assets that implement the electronic access control(s) specified by the Responsible Entity in Attachment 1, Section 3.1, if any. If these Cyber Assets implementing the electronic access controls are located within the same asset as the low impact BES Cyber Asset(s) and inherit the same physical access controls and the same need as outlined in Section 2, this may be noted by the Responsible Entity in either its policies or cyber security plan(s) to avoid duplicate documentation of the same controls.

The Responsible Entity has the flexibility to select the methods used to meet the objective of controlling physical access to (1) the asset(s) containing low impact BES Cyber System(s) or the low impact BES Cyber Systems themselves and (2) the electronic access control Cyber Assets specified by the Responsible Entity, if any. The Responsible Entity may use one or a

combination of physical access controls, monitoring controls, or other operational, procedural, or technical physical security controls. Entities may use perimeter controls (e.g., fences with locked gates, guards, or site access policies, etc.) or more granular areas of physical access control in areas where low impact BES Cyber Systems are located, such as control rooms or control houses.

The security objective is to control the physical access based on need as determined by the Responsible Entity. The need for physical access can be documented at the policy level. The standard drafting team did not intend to obligate an entity to specify a need for each physical access or authorization of an individual for physical access.

Monitoring as a physical security control can be used as a complement or an alternative to physical access control. Examples of monitoring controls include, but are not limited to: (1) alarm systems to detect motion or entry into a controlled area, or (2) human observation of a controlled area. Monitoring does not necessarily require logging and maintaining logs but could include monitoring that physical access has occurred or been attempted (e.g., door alarm, or human observation, etc.). The standard drafting team's intent is that the monitoring does not need to be per low impact BES Cyber System but should be at the appropriate level to meet the security objective of controlling physical access.

User authorization programs and lists of authorized users for physical access are not required although they are an option to meet the security objective.

Requirement R2, Attachment 1, Section 3 – Electronic Access Controls

Section 3 requires the establishment of electronic access controls for assets containing low impact BES Cyber Systems when there is routable protocol communication or Dial-up Connectivity between Cyber Asset(s) outside of the asset containing the low impact BES Cyber System(s) and the low impact BES Cyber System(s) within such asset. The establishment of electronic access controls is intended to reduce the risks associated with uncontrolled communication using routable protocols or Dial-up Connectivity.

When implementing Attachment 1, Section 3.1, Responsible Entities should note that electronic access controls to permit only necessary inbound and outbound electronic access are required for communications when those communications meet all three of the criteria identified in Attachment 1, Section 3.1. The Responsible Entity should evaluate the communications and when all three criteria are met, the Responsible Entity must document and implement electronic access control(s).

When identifying electronic access controls, Responsible Entities are provided flexibility in the selection of the electronic access controls that meet their operational needs while meeting the security objective of allowing only necessary inbound and outbound electronic access to low impact BES Cyber Systems that use routable protocols between a low impact BES Cyber System(s) and Cyber Asset(s) outside the asset.

In essence, the intent is for Responsible Entities to determine whether there is communication between a low impact BES Cyber System(s) and a Cyber Asset(s) outside the asset containing low impact BES Cyber System(s) that uses a routable protocol when entering or leaving the asset or Dial-up Connectivity to the low impact BES Cyber System(s). Where such

communication is present, Responsible Entities should document and implement electronic access control(s). Where routable protocol communication for time-sensitive protection or control functions between intelligent electronic devices that meets the exclusion language is present, Responsible Entities should document that communication, but are not required to establish any specific electronic access controls.

The inputs to this requirement are the assets identified in CIP-002 as containing low impact BES Cyber System(s); therefore, the determination of routable protocol communications or Dial-up Connectivity is an attribute of the asset. However, it is not intended for communication that provides no access to or from the low impact BES Cyber System(s), but happens to be located at the asset with the low impact BES Cyber System(s), to be evaluated for electronic access controls.

Electronic Access Control Exclusion

In order to avoid future technology issues, the obligations for electronic access controls exclude communications between intelligent electronic devices that use routable communication protocols for time-sensitive protection or control functions, such as IEC TR-61850-90-5 R-GOOSE messaging. Time-sensitive in this context generally means functions that would be negatively impacted by the latency introduced in the communications by the required electronic access controls. This time-sensitivity exclusion does not apply to SCADA communications which typically operate on scan rates of 2 seconds or greater. While technically time-sensitive, SCADA communications over routable protocols can withstand the delay introduced by electronic access controls. Examples of excluded time-sensitive communications are those communications which may necessitate the tripping of a breaker within a few cycles. A Responsible Entity using this technology is not expected to implement the electronic access controls noted herein. This exception was included so as not to inhibit the functionality of the time-sensitive characteristics related to this technology and not to preclude the use of such time-sensitive reliability enhancing functions if they use a routable protocol in the future.

Considerations for Determining Routable Protocol Communications

To determine whether electronic access controls need to be implemented, the Responsible Entity has to determine whether there is communication between a low impact BES Cyber System(s) and a Cyber Asset(s) outside the asset containing the low impact BES Cyber System(s) that uses a routable protocol when entering or leaving the asset.

When determining whether a routable protocol is entering or leaving the asset containing the low impact BES Cyber System(s), Responsible Entities have flexibility in identifying an approach. One approach is for Responsible Entities to identify an “electronic boundary” associated with the asset containing low impact BES Cyber System(s). This is not an Electronic Security Perimeter *per se*, but a demarcation that demonstrates the routable protocol communication entering or leaving the asset between a low impact BES Cyber System and Cyber Asset(s) outside the asset to then have electronic access controls implemented. This electronic boundary may vary by asset type (Control Center, substation, generation resource) and the specific configuration of the asset. If this approach is used, the intent is for the Responsible Entity to define the electronic boundary such that the low impact BES Cyber System(s) located

at the asset are contained within the “electronic boundary.” This is strictly for determining which routable protocol communications and networks are internal or inside or local to the asset and which are external to or outside the asset.

Alternatively, the Responsible Entity may find the concepts of what is inside and outside to be intuitively obvious for a Cyber Asset(s) outside the asset containing low impact BES Cyber System(s) communicating to a low impact BES Cyber System(s) inside the asset. This may be the case when a low impact BES Cyber System(s) is communicating with a Cyber Asset many miles away and a clear and unambiguous demarcation exists. In this case, a Responsible Entity may decide not to identify an “electronic boundary,” but rather to simply leverage the unambiguous asset demarcation to ensure that the electronic access controls are placed between the low impact BES Cyber System(s) and the Cyber Asset(s) outside the asset.

Determining Electronic Access Controls

Once a Responsible Entity has determined that there is routable communication between a low impact BES Cyber System(s) and a Cyber Asset(s) outside the asset containing the low impact BES Cyber System(s) that uses a routable protocol when entering or leaving the asset containing the low impact BES Cyber System(s), the intent is for the Responsible Entity to document and implement its chosen electronic access control(s). The control(s) are intended to allow only “necessary” inbound and outbound electronic access as determined by the Responsible Entity. However the Responsible Entity chooses to document the inbound and outbound access permissions and the need, the intent is that the Responsible Entity is able to explain the reasons for the electronic access permitted. The reasoning for “necessary” inbound and outbound electronic access controls may be documented within the Responsible Entity’s cyber security plan(s), within a comment on an access control list, a database, spreadsheet or other policies or procedures associated with the electronic access controls.

Concept Diagrams

The diagrams on the following pages are provided as examples to illustrate various electronic access controls at a conceptual level. Regardless of the concepts or configurations chosen by the Responsible Entity, the intent is to achieve the security objective of permitting only necessary inbound and outbound electronic access for communication between low impact BES Cyber Systems and Cyber Asset(s) outside the asset containing the low impact BES Cyber System(s) using a routable protocol when entering or leaving the asset.

NOTE:

- This is not an exhaustive list of applicable concepts.
- The same legend is used in each diagram; however, the diagram may not contain all of the articles represented in the legend.

Reference Model 1 – Host-based Inbound & Outbound Access Permissions

The Responsible Entity may choose to utilize a host-based firewall technology on the low impact BES Cyber System(s) itself that manages the inbound and outbound electronic access permissions so that only necessary inbound and outbound electronic access is allowed between the low impact BES Cyber System(s) and the Cyber Asset(s) outside the asset containing the low impact BES Cyber System(s). When permitting the inbound and outbound electronic access permissions using access control lists, the Responsible Entity could restrict communication(s) using source and destination addresses or ranges of addresses. Responsible Entities could also restrict communication(s) using ports or services based on the capability of the electronic access control, the low impact BES Cyber System(s), or the application(s).

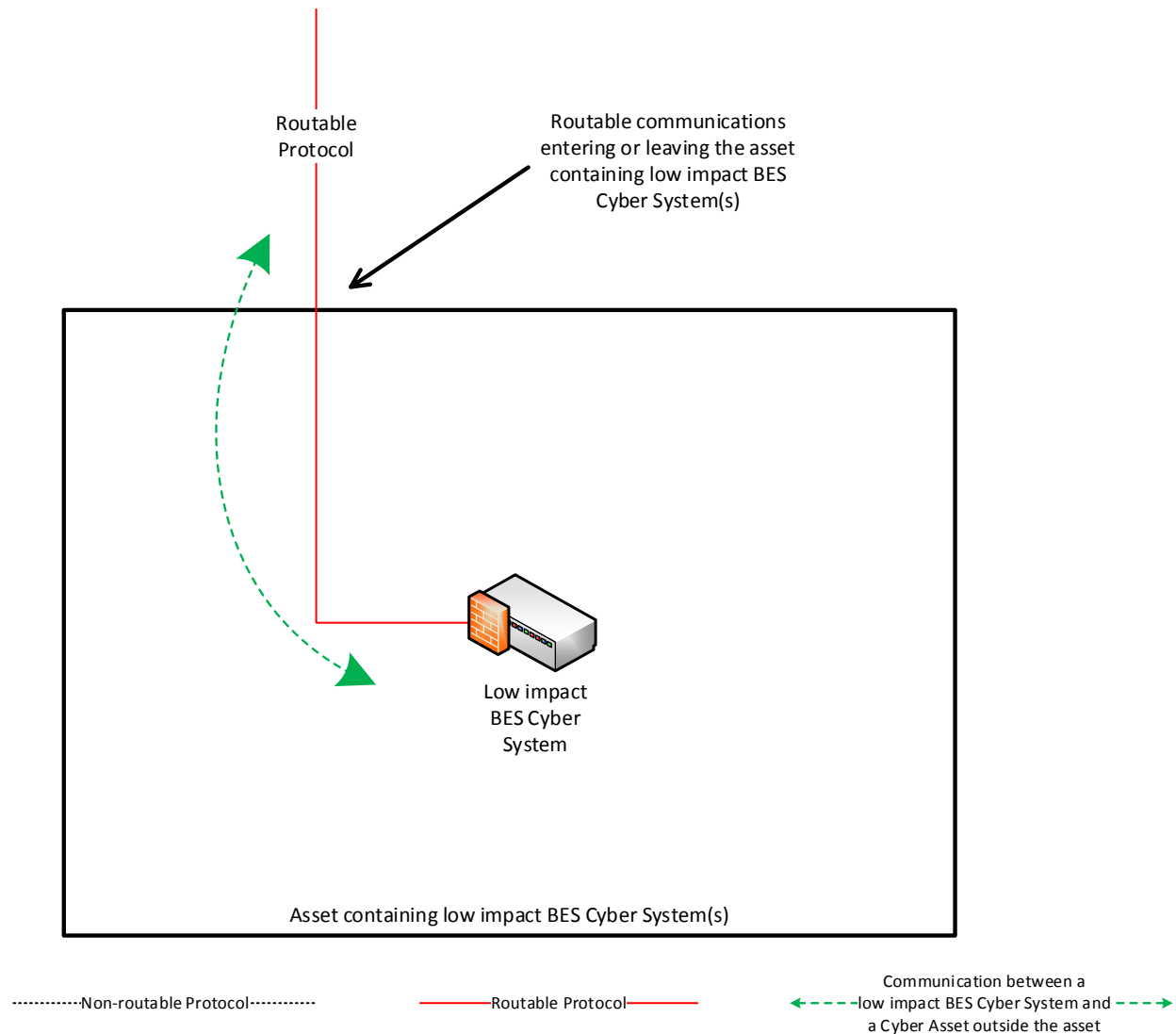

Reference Model 1

Reference Model 2 – Network-based Inbound & Outbound Access Permissions

The Responsible Entity may choose to use a security device that permits only necessary inbound and outbound electronic access to the low impact BES Cyber System(s) within the asset containing the low impact BES Cyber System(s). In this example, two low impact BES Cyber Systems are accessed using the routable protocol that is entering or leaving the asset containing the low impact BES Cyber System(s). The IP/Serial converter is continuing the same communications session from the Cyber Asset(s) that are outside the asset to the low impact BES Cyber System(s). The security device provides the electronic access controls to permit only necessary inbound and outbound routable protocol access to the low impact BES Cyber System(s). When permitting the inbound and outbound electronic access permissions using access control lists, the Responsible Entity could restrict communication(s) using source and destination addresses or ranges of addresses. Responsible Entities could also restrict communication(s) using ports or services based on the capability of the electronic access control, the low impact BES Cyber System(s), or the application(s).

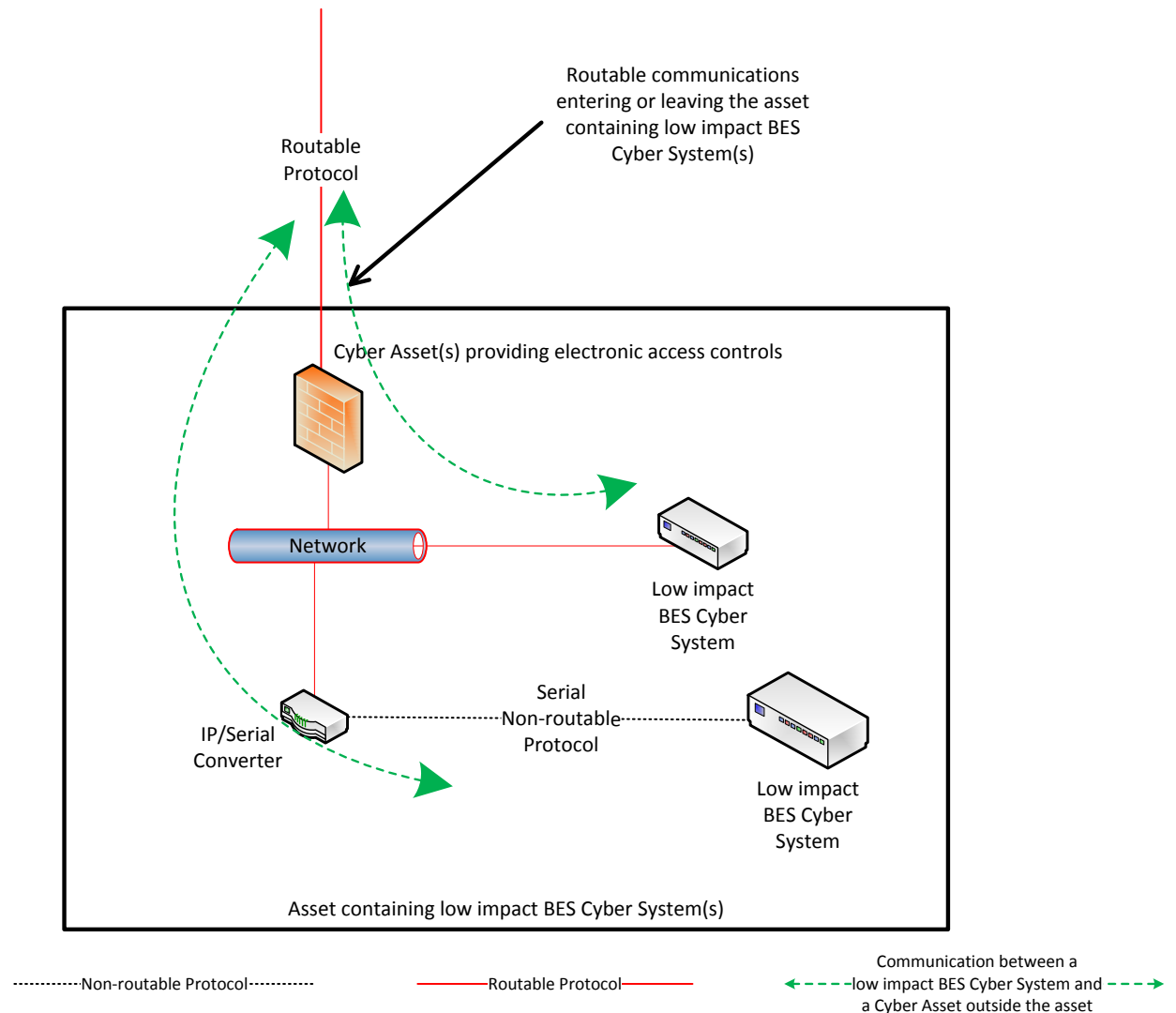

Reference Model 2

Reference Model 3 – Centralized Network-based Inbound & Outbound Access Permissions

The Responsible Entity may choose to utilize a security device at a centralized location that may or may not be at another asset containing low impact BES Cyber System(s). The electronic access control(s) do not necessarily have to reside inside the asset containing the low impact BES Cyber System(s). A security device is in place at “Location X” to act as the electronic access control and permit only necessary inbound and outbound routable protocol access between the low impact BES Cyber System(s) and the Cyber Asset(s) outside each asset containing low impact BES Cyber System(s). Care should be taken that electronic access to or between each asset is through the Cyber Asset(s) determined by the Responsible Entity to be performing electronic access controls at the centralized location. When permitting the inbound and outbound electronic access permissions using access control lists, the Responsible Entity could restrict communication(s) using source and destination addresses or ranges of addresses. Responsible Entities could also restrict communication(s) using ports or services based on the capability of the electronic access control, the low impact BES Cyber System(s), or the application(s).

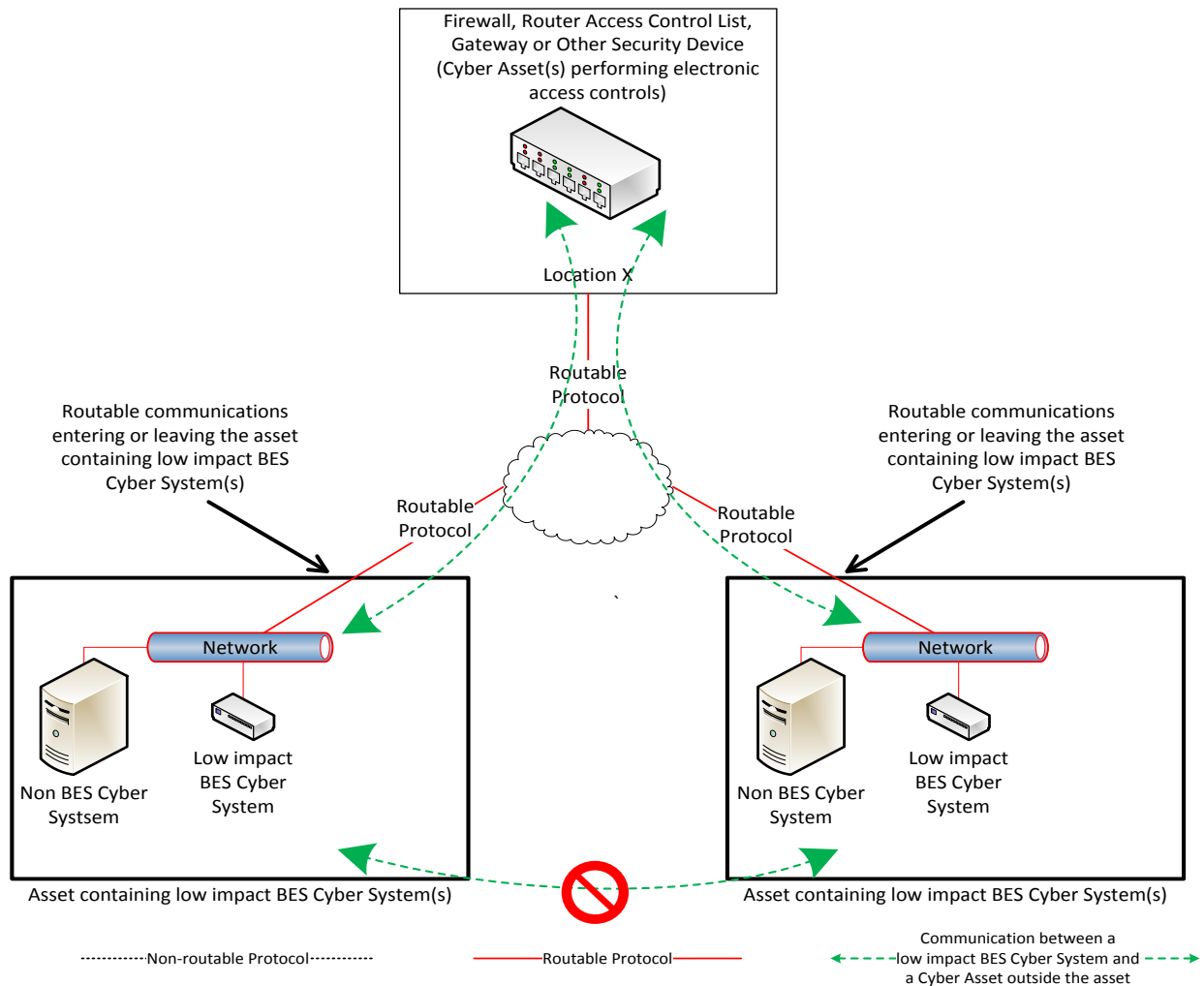

Reference Model 3

Reference Model 4 – Uni-directional Gateway

The Responsible Entity may choose to utilize a uni-directional gateway as the electronic access control. The low impact BES Cyber System(s) is not accessible (data cannot flow into the low impact BES Cyber System) using the routable protocol entering the asset due to the implementation of a “one-way” (uni-directional) path for data to flow. The uni-directional gateway is configured to permit only the necessary outbound communications using the routable protocol communication leaving the asset.

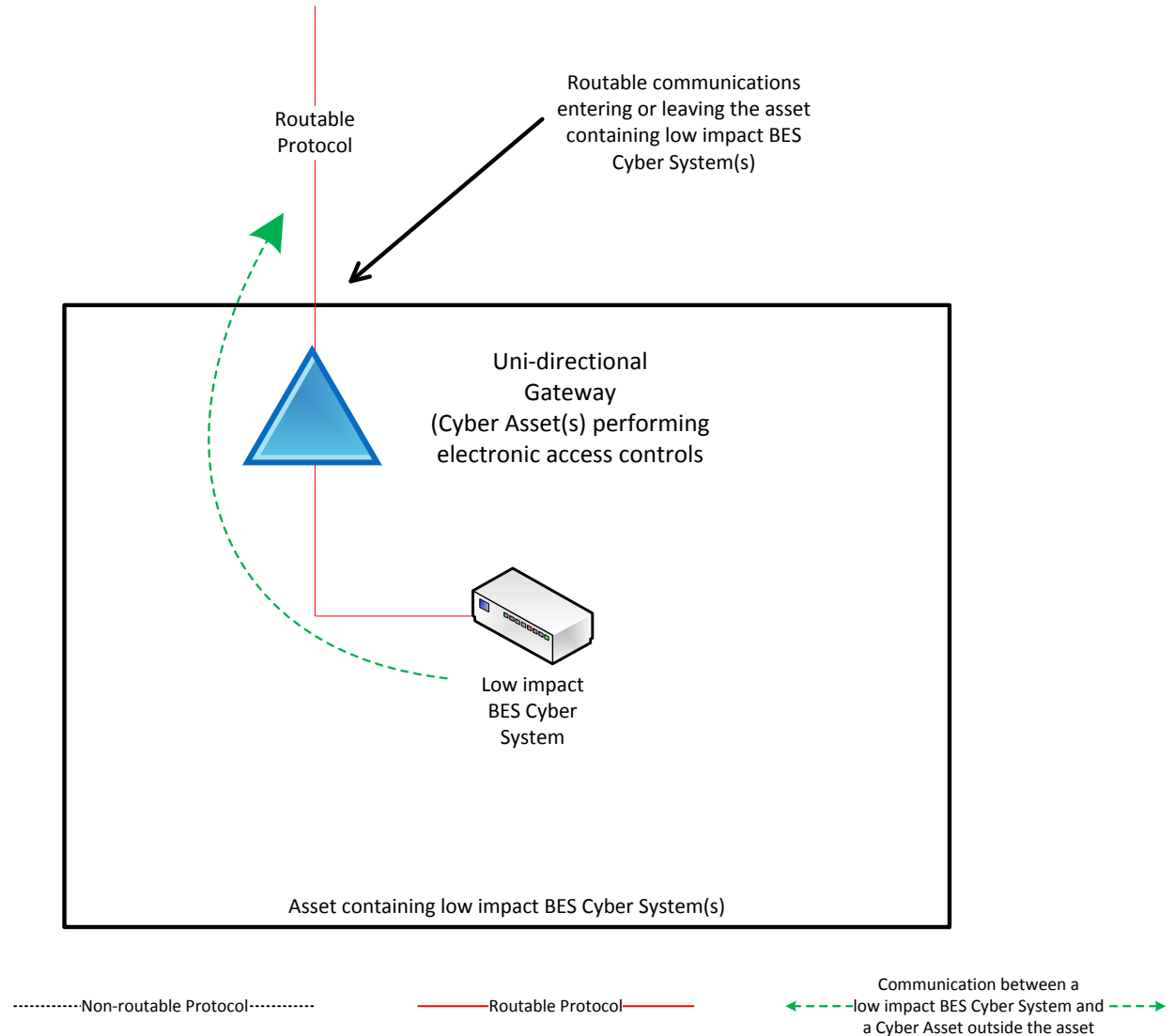

Reference Model 4

Reference Model 5 – User Authentication

This reference model demonstrates that Responsible Entities have flexibility in choosing electronic access controls so long as the security objective of the requirement is met. The Responsible Entity may choose to utilize a non-BES Cyber Asset located at the asset containing the low impact BES Cyber System that requires authentication for communication from the Cyber Asset(s) outside the asset. This non-BES Cyber System performing the authentication permits only authenticated communication to connect to the low impact BES Cyber System(s), meeting the first half of the security objective to permit only necessary inbound electronic access. Additionally, the non-BES Cyber System performing authentication is configured such that it permits only necessary outbound communication meeting the second half of the security objective. Often, the outbound communications would be controlled in this network architecture by permitting no communication to be initiated from the low impact BES Cyber System. This configuration may be beneficial when the only communication to a device is for user-initiated interactive access.

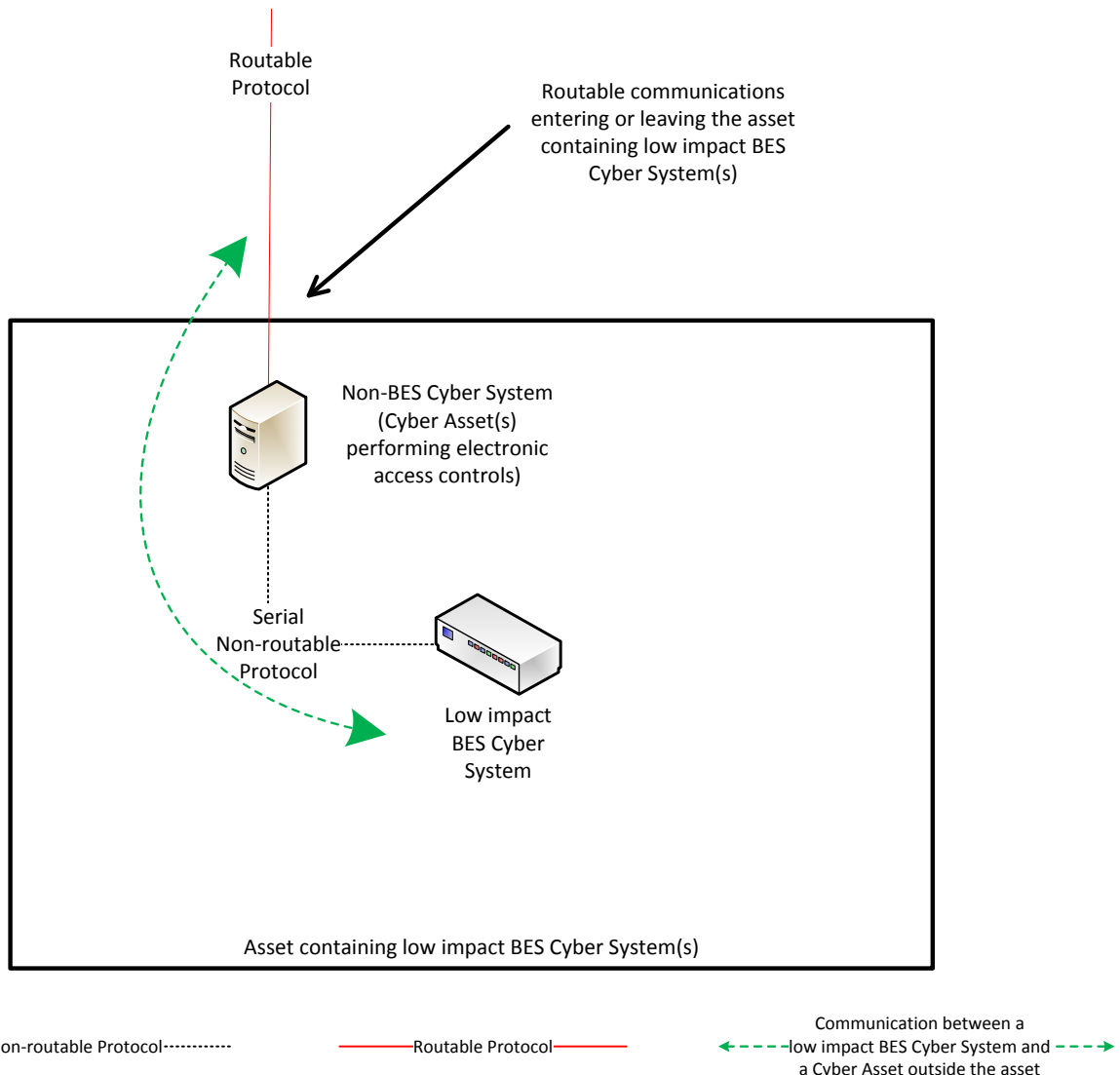

Reference Model 5

Reference Model 6 – Indirect Access

In implementing its electronic access controls, the Responsible Entity may identify that it has indirect access between the low impact BES Cyber System and a Cyber Asset outside the asset containing the low impact BES Cyber System through a non-BES Cyber Asset located within the asset. This indirect access meets the criteria of having communication between the low impact BES Cyber System and a Cyber Asset outside the asset containing the low impact BES Cyber System. In this reference model, it is intended that the Responsible Entity implement electronic access controls that permit only necessary inbound and outbound electronic access to the low impact BES Cyber System. Consistent with the other reference models provided, the electronic access in this reference model is controlled using the security device that is restricting the communication that is entering or leaving the asset.

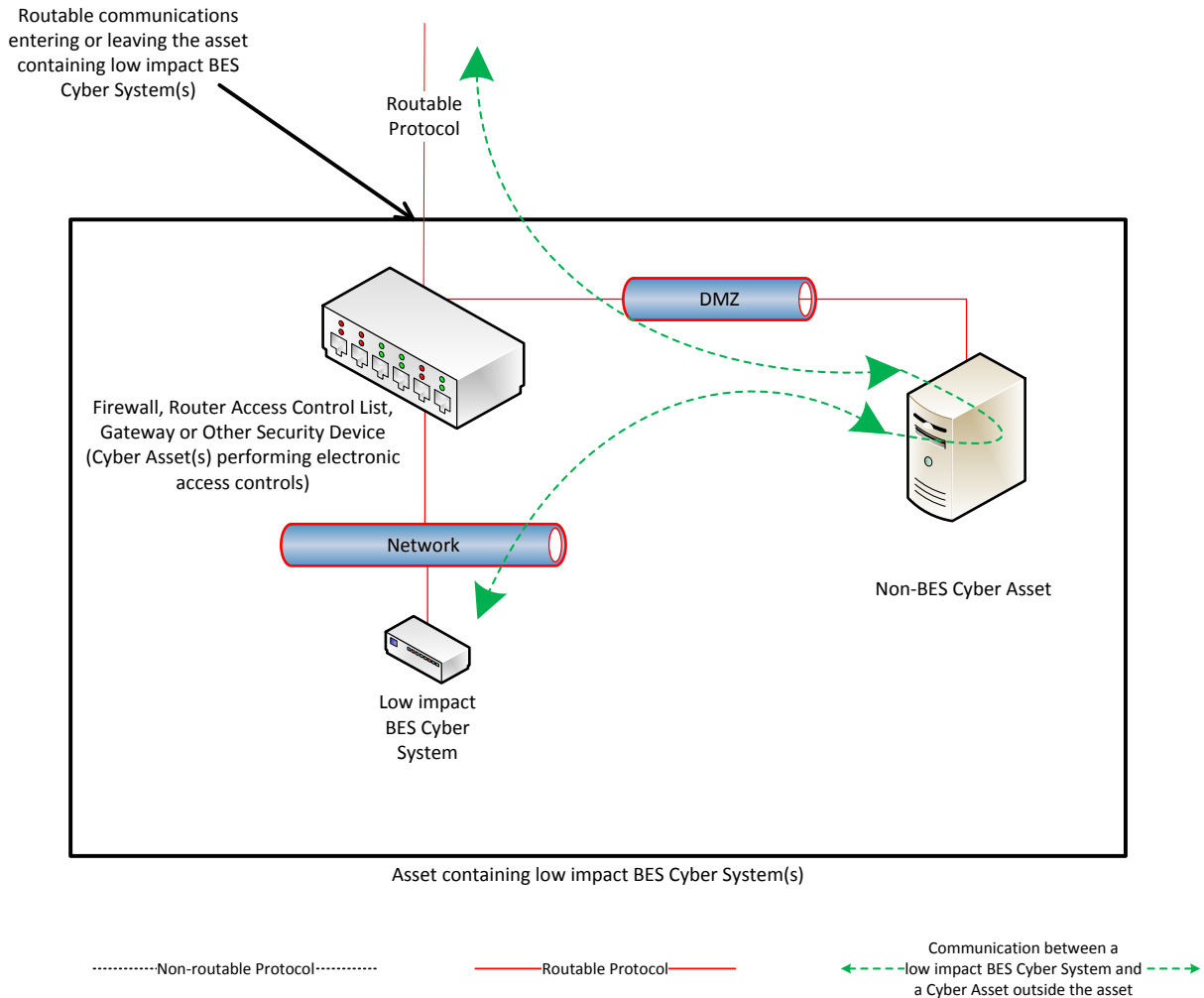

Reference Model 6

Reference Model 7 – Electronic Access Controls at assets containing low impact BES Cyber Systems and ERC

In this reference model, there is both a routable protocol entering and leaving the asset containing the low impact BES Cyber System(s) that is used by Cyber Asset(s) outside the asset and External Routable Connectivity because there is at least one medium impact BES Cyber System and one low impact BES Cyber System within the asset using the routable protocol communications. The Responsible Entity may choose to leverage an interface on the medium impact Electronic Access Control or Monitoring Systems (EACMS) to provide electronic access controls for purposes of CIP-003. The EACMS is therefore performing multiple functions – as a medium impact EACMS and as implementing electronic access controls for an asset containing low impact BES Cyber Systems.

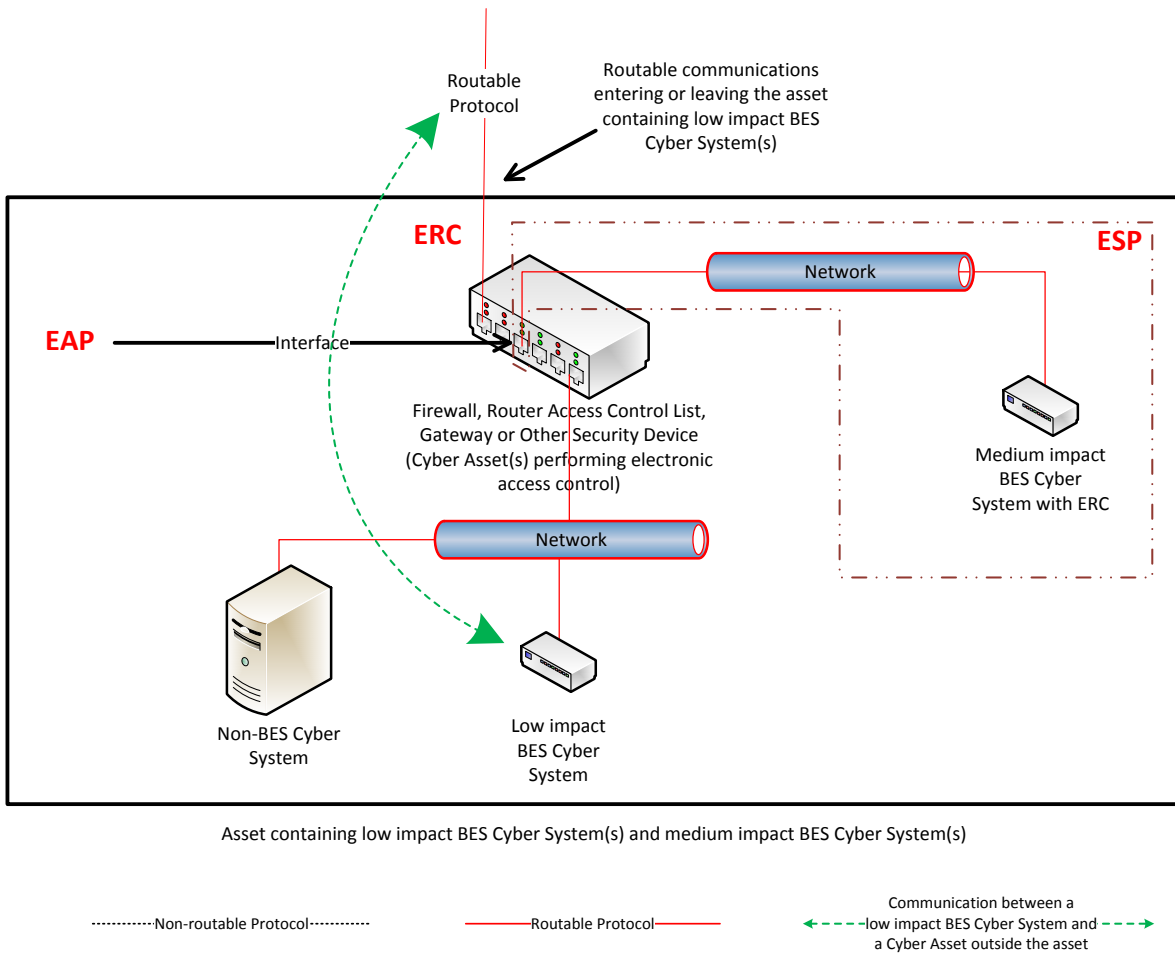

Reference Model 7

Reference Model 8 – Physical Isolation and Serial Non-routable Communications – No Electronic Access Controls Required

In this reference model, the criteria from Attachment 1, Section 3.1 requiring the implementation of electronic access controls are not met. This reference model demonstrates three concepts:

- 1) The physical isolation of the low impact BES Cyber System(s) from the routable protocol communication entering or leaving the asset containing the low impact BES Cyber System(s), commonly referred to as an 'air gap', mitigates the need to implement the required electronic access controls;
- 2) The communication to the low impact BES Cyber System from a Cyber Asset outside the asset containing the low impact BES Cyber System(s) using only a serial non-routable protocol where such communication is entering or leaving the asset mitigates the need to implement the required electronic access controls.
- 3) The routable protocol communication between the low impact BES Cyber System(s) and other Cyber Asset(s), such as the second low impact BES Cyber System depicted, may exist without needing to implement the required electronic access controls so long as the routable protocol communications never leaves the asset containing the low impact BES Cyber System(s).

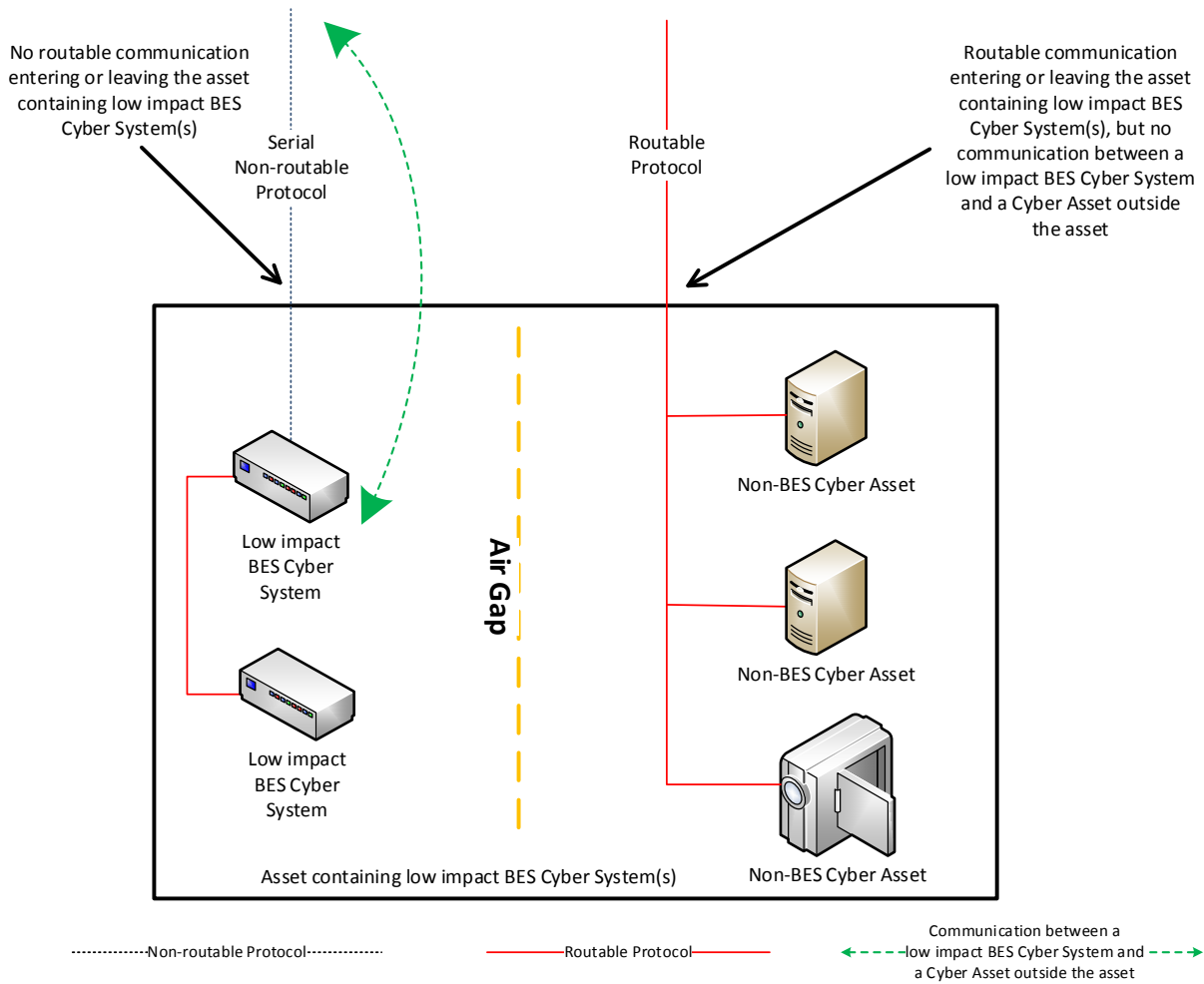

Reference Model 8

Reference Model 9 – Logical Isolation - No Electronic Access Controls Required

In this reference model, the criteria from Attachment 1, Section 3.1 requiring the implementation of electronic access controls are not met. The Responsible Entity has logically isolated the low impact BES Cyber System(s) from the routable protocol communication entering or leaving the asset containing low impact BES Cyber System(s). The logical network segmentation in this reference model permits no communication between a low impact BES Cyber System and a Cyber Asset outside the asset. Additionally, no indirect access exists because those non-BES Cyber Assets that are able to communicate outside the asset are strictly prohibited from communicating to the low impact BES Cyber System(s). The low impact BES Cyber System(s) is on an isolated network segment with logical controls preventing routable protocol communication into or out of the network containing the low impact BES Cyber System(s) and these communications never leave the asset using a routable protocol.

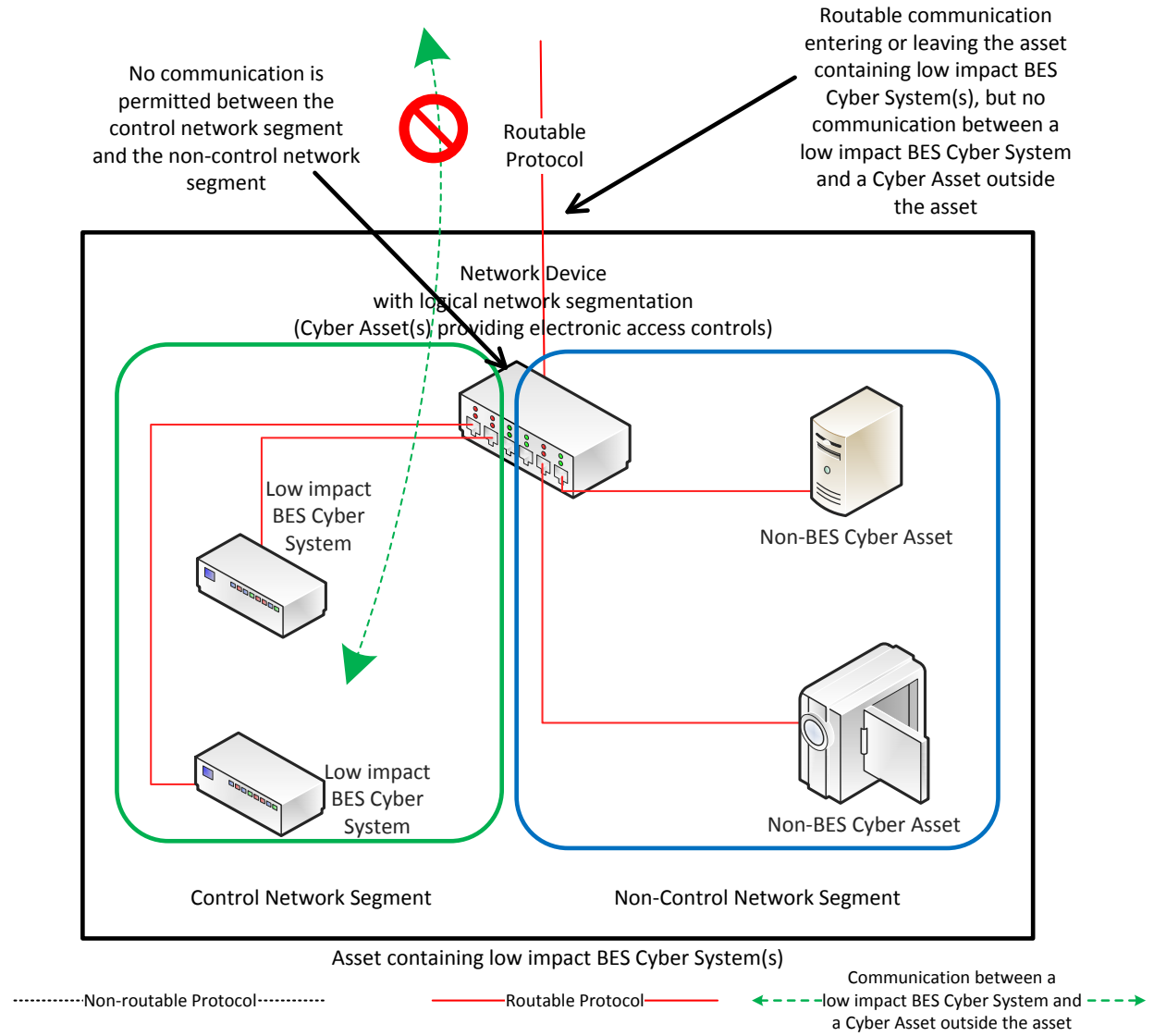

Reference Model 9

Reference Model 10 - Serial Non-routable Communications Traversing an Isolated Channel on a Non-routable Transport Network – No Electronic Access Controls Required

In this reference model, the criteria from Attachment 1, Section 3.1 requiring the implementation of electronic access controls are not met. This reference model depicts communication between a low impact BES Cyber System and a Cyber Asset outside the asset containing the low impact BES Cyber System over a serial non-routable protocol which is transported across a wide-area network using a protocol independent transport that may carry routable and non-routable communication such as a Time-Division Multiplexing (TDM) network, a Synchronous Optical Network (SONET), or a Multiprotocol Label Switching (MPLS) network. While there is routable protocol communication entering or leaving the asset containing low impact BES Cyber Systems(s) and there is communication between a low impact BES Cyber System and a Cyber Asset outside the asset, the communication between the low impact BES Cyber System and the Cyber Asset outside the asset is not using the routable protocol communication. This model is related to Reference Model 9 in that it relies on logical isolation to prohibit the communication between a low impact BES Cyber System and a Cyber Asset outside the asset from using a routable protocol.

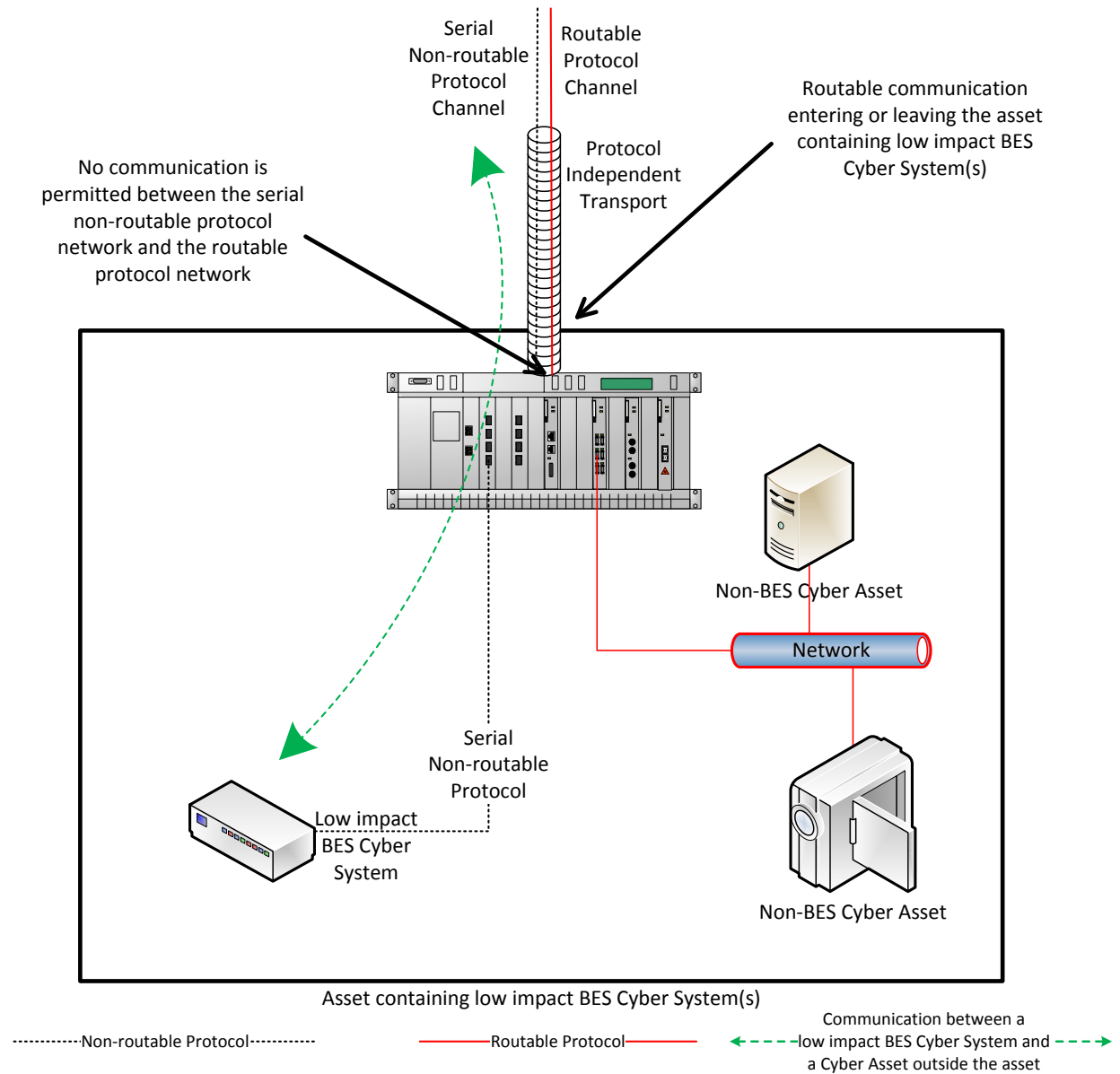

Reference Model 10

Dial-up Connectivity

Dial-up Connectivity to a low impact BES Cyber System is set to dial out only (no auto-answer) to a preprogrammed number to deliver data. Incoming Dial-up Connectivity is to a dialback modem, a modem that must be remotely controlled by the control center or control room, has some form of access control, or the low impact BES Cyber System has access control.

Insufficient Access Controls

Some examples of situations that would lack sufficient access controls to meet the intent of this requirement include:

- An asset has Dial-up Connectivity and a low impact BES Cyber System is reachable via an auto-answer modem that connects any caller to the Cyber Asset that has a default password. There is no practical access control in this instance.
- A low impact BES Cyber System has a wireless card on a public carrier that allows the BES Cyber System to be reachable via a public IP address. In essence, low impact BES Cyber Systems should not be accessible from the Internet and search engines such as Shodan.
- Dual-homing or multiple-network interface cards without disabling IP forwarding in the non-BES Cyber Asset within the DMZ to provide separation between the low impact BES Cyber System(s) and the external network would not meet the intent of “controlling” inbound and outbound electronic access assuming there was no other host-based firewall or other security devices on the non-BES Cyber Asset.

Requirement R2, Attachment 1, Section 4 – Cyber Security Incident Response

The entity should have one or more documented Cyber Security Incident response plan(s) that include each of the topics listed in Section 4. If, in the normal course of business, suspicious activities are noted at an asset containing low impact BES Cyber System(s), the intent is for the entity to implement a Cyber Security Incident response plan that will guide the entity in responding to the incident and reporting the incident if it rises to the level of a Reportable Cyber Security Incident.

Entities are provided the flexibility to develop their Attachment 1, Section 4 Cyber Security Incident response plan(s) by asset or group of assets. The plans do not need to be on a per asset site or per low impact BES Cyber System basis. Entities can choose to use a single enterprise-wide plan to fulfill the obligations for low impact BES Cyber Systems.

The plan(s) must be tested once every 36 months. This is not an exercise per low impact BES Cyber Asset or per type of BES Cyber Asset but rather is an exercise of each incident response plan the entity created to meet this requirement. An actual Reportable Cyber Security Incident counts as an exercise as do other forms of tabletop exercises or drills. NERC-led exercises such as GridEx participation would also count as an exercise provided the entity’s response plan is followed. The intent of the requirement is for entities to keep the Cyber Security Incident response plan(s) current, which includes updating the plan(s), if needed, within 180 days following a test or an actual incident.

For low impact BES Cyber Systems, the only portion of the definition of Cyber Security Incident that would apply is, “A malicious act or suspicious event that disrupts, or was an attempt to

disrupt, the operation of a BES Cyber System.” The other portion of that definition is not to be used to require ESPs and PSPs for low impact BES Cyber Systems.

Requirement R2, Attachment 1, Section 5 – Transient Cyber Assets and Removable Media Malicious Code Risk Mitigation

Most BES Cyber Assets and BES Cyber Systems are isolated from external public or untrusted networks, and therefore Responsible Entities need Transient Cyber Assets and Removable Media to transport files to and from secure areas to maintain, monitor, or troubleshoot critical systems. Transient Cyber Assets and Removable Media are a potential means for cyber-attack. To protect the BES Cyber Assets and BES Cyber Systems, CIP-003 Requirement R2, Attachment 1, Section 5 requires Responsible Entities to document and implement a plan for how they will mitigate the risk of malicious code introduction to low impact BES Cyber Systems from Transient Cyber Assets and Removable Media. The approach of defining a plan allows the Responsible Entity to document processes that are supportable within its organization and in alignment with its change management processes.

Transient Cyber Assets can be one of many types of devices, including specially-designed devices for maintaining equipment in support of the BES or a platform such as a laptop, desktop, or tablet that may interface with or run applications that support BES Cyber Systems and is capable of transmitting executable code to the BES Cyber Asset(s) or BES Cyber System(s). Note: Cyber Assets connected to a BES Cyber System for less than 30 days due to an unplanned removal, such as premature failure, are not intended to be identified as Transient Cyber Assets. Removable Media subject to this requirement include, among others, floppy disks, compact disks, USB flash drives, external hard drives, and other flash memory cards/drives that contain nonvolatile memory.

Examples of these temporarily connected devices include, but are not limited to:

- Diagnostic test equipment;
- Equipment used for BES Cyber System maintenance; or
- Equipment used for BES Cyber System configuration.

To meet the objective of mitigating risks associated with the introduction of malicious code at low impact BES Cyber Systems, Section 5 specifies the capabilities and possible security methods available to Responsible Entities based upon asset type and ownership.

With the list of options provided in Attachment 1, the entity has the discretion to use the option(s) that is most appropriate. This includes documenting its approach for how and when the entity reviews the Transient Cyber Asset under its control or under the control of parties other than the Responsible Entity. The entity should avoid implementing a security function that jeopardizes reliability by taking actions that would negatively impact the performance or support of the Transient Cyber Asset or BES Cyber Asset.

Vulnerability Mitigation

The terms “mitigate”, “mitigating”, and “mitigation” are used in the sections in Attachment 1 to address the risks posed by malicious code when connecting Transient Cyber Assets and Removable Media to BES Cyber Systems. Mitigation in this context does not necessarily require that each vulnerability be individually addressed or remediated, as many vulnerabilities may be unknown or not have an impact on the system to which the Transient Cyber Asset or Removable Media is connected. Mitigation is intended to mean that entities take steps to reduce security risks presented by connecting the Transient Cyber Asset or Removable Media.

Per Transient Cyber Asset Capability

As with other CIP standards, the requirements are intended for an entity to use the method(s) that the system is capable of performing. The use of “per Transient Cyber Asset capability” is to eliminate the need for a Technical Feasibility Exception when it is understood that the device cannot use a method(s). For example, for malicious code, many types of appliances are not capable of implementing antivirus software; therefore, because it is not a capability of those types of devices, implementation of the antivirus software would not be required for those devices.

Requirement R2, Attachment 1, Section 5.1 - Transient Cyber Asset(s) Managed by the Responsible Entity

For Transient Cyber Assets and Removable Media that are connected to both low impact and medium/high impact BES Cyber Systems, entities must be aware of the differing levels of requirements and manage these assets under the program that matches the highest impact level to which they will connect.

Section 5.1: Entities are to document and implement their process(es) to mitigate malicious code through the use of one or more of the protective measures listed, based on the capability of the Transient Cyber Asset. When addressing malicious code protection, Section 5.1 obligates the Responsible Entities to implement methods to mitigate the introduction of malicious code on Transient Cyber Assets managed by the Responsible Entity.

The Responsible Entity has the flexibility to apply the selected method(s) to meet the objective of mitigating the introductions of malicious code either in an on-going or in an on-demand manner. An example of managing a device in an on-going manner is having the antivirus solution for the device managed as part of an end-point security solution with current signature or pattern updates, regularly scheduled systems scans, etc. In contrast, for devices that are used infrequently and the signatures or patterns are not kept current, the entity may manage those devices in an on-demand manner by requiring an update to the signatures or patterns and a scan of the device before the device is connected to ensure that it is free of malicious code.

Selecting management in an on-going or on-demand manner is not intended to imply that the control has to be verified at every single connection. For example, if the device is managed in an on-demand manner, but will be used to perform maintenance on several BES Cyber Asset(s), the Responsible Entity may choose to document that the Transient Cyber Asset has been updated before being connected as a Transient Cyber Asset for the first use of that

maintenance work. The intent is not to require a log documenting each connection of a Transient Cyber Asset to a BES Cyber Asset.

Selecting management in an on-going or on-demand manner is not intended to imply that the control has to be verified at every single connection. For example, if the device is managed in an on-demand manner, but will be used to perform maintenance on several BES Cyber Asset(s), the Responsible Entity may choose to document that the Transient Cyber Asset has been updated before being connected as a Transient Cyber Asset for the first use of that maintenance work. The intent is not to require a log documenting each connection of a Transient Cyber Asset to a BES Cyber Asset.

The following is some additional discussion of the methods to mitigate the introduction of malicious code.

- Antivirus software, including manual or managed updates of signatures or patterns, provides flexibility to manage Transient Cyber Asset(s) by deploying antivirus or endpoint security tools that maintain a scheduled update of the signatures or patterns. Also, for devices that do not regularly connect to receive scheduled updates, entities may choose to update the signatures or patterns and scan the Transient Cyber Asset prior to connection to ensure no malicious software is present.
- Application whitelisting is a method of authorizing only the applications and processes that are necessary on the Transient Cyber Asset. This reduces the risk that malicious software could execute on the Transient Cyber Asset and impact the BES Cyber Asset or BES Cyber System.
- If a Responsible Entity chooses to use methods that mitigate the introduction of malicious code other than those listed, it should document how the other method(s) meet the mitigation of the introduction of malicious code objective.

If malicious code is discovered, it must be mitigated to prevent it from being introduced into the BES Cyber Asset or BES Cyber System. Entities should also consider whether the detected malicious code is a Cyber Security Incident.

Requirement R2, Attachment 1, Section 5.2 - Transient Cyber Asset(s) Managed by a Party Other than the Responsible Entity

Section 5 also recognizes the lack of direct control over Transient Cyber Assets that are managed by parties other than the Responsible Entity. This lack of control, however, does not obviate the Responsible Entity's responsibility to ensure that methods have been deployed to mitigate the introduction of malicious code to low impact BES Cyber System(s) from Transient Cyber Assets it does not manage. Section 5 requires entities to review the other party's security practices with respect to Transient Cyber Assets to help meet the objective of the requirement. The use of "prior to connecting the Transient Cyber Assets" is intended to ensure that the Responsible Entity conducts the review before the first connection of the Transient Cyber Asset to help meet the objective to mitigate the introduction of malicious code. The SDT does not intend for the Responsible Entity to conduct a review for every single connection of that Transient Cyber Asset once the Responsible Entity has established the Transient Cyber Asset is

meeting the security objective. The intent is also not to require a log documenting each connection of a Transient Cyber Asset to a BES Cyber Asset.

To facilitate these controls, Responsible Entities may execute agreements with other parties to provide support services to BES Cyber Systems and BES Cyber Assets that may involve the use of Transient Cyber Assets. Entities may consider using the Department of Energy Cybersecurity Procurement Language for Energy Delivery dated April 2014.¹ Procurement language may unify the other party's and entity's actions supporting the BES Cyber Systems and BES Cyber Assets. CIP program attributes may be considered including roles and responsibilities, access controls, monitoring, logging, vulnerability, and patch management along with incident response and back up recovery may be part of the other party's support. Entities should consider the "General Cybersecurity Procurement Language" and "The Supplier's Life Cycle Security Program" when drafting Master Service Agreements, Contracts, and the CIP program processes and controls.

Section 5.2: Entities are to document and implement their process(es) to mitigate the introduction of malicious code through the use of one or more of the protective measures listed.

- Review the use of antivirus software and signature or pattern levels to ensure that the level is adequate to the Responsible Entity to mitigate the risk of malicious software being introduced to an applicable system.
- Review the antivirus or endpoint security processes of the other party to ensure that their processes are adequate to the Responsible Entity to mitigate the risk of introducing malicious software to an applicable system.
- Review the use of application whitelisting used by the other party to mitigate the risk of introducing malicious software to an applicable system.
- Review the use of live operating systems or software executable only from read-only media to ensure that the media is free from malicious software itself. Entities should review the processes to build the read-only media as well as the media itself.
- Review system hardening practices used by the other party to ensure that unnecessary ports, services, applications, etc. have been disabled or removed. This measure helps to reduce the attack surface on the Transient Cyber Asset and reduce the avenues by which malicious software could be introduced.

Requirement R2, Attachment 1, Section 5.3 - Removable Media

Entities have a high level of control for Removable Media that are going to be connected to their BES Cyber Assets.

¹ <http://www.energy.gov/oe/downloads/cybersecurity-procurement-language-energy-delivery-april-2014>

Section 5.3: Entities are to document and implement their process(es) to mitigate the introduction of malicious code through the use of one or more method(s) to detect malicious code on the Removable Media before it is connected to a BES Cyber Asset. When using the method(s) to detect malicious code, it is expected to occur from a system that is not part of the BES Cyber System to reduce the risk of propagating malicious code into the BES Cyber System network or onto one of the BES Cyber Assets. If malicious code is discovered, it must be removed or mitigated to prevent it from being introduced into the BES Cyber Asset or BES Cyber System. Entities should also consider whether the detected malicious code is a Cyber Security Incident. Frequency and timing of the methods used to detect malicious code were intentionally excluded from the requirement because there are multiple timing scenarios that can be incorporated into a plan to mitigate the risk of malicious code. However, the SDT does not intend for a Responsible Entity to conduct a review for every single connection of that Removable Media, but implement their process(es) in manner that protects all BES Cyber Systems where the Removable Media may be used. The intent is also not to require a log documenting each connection of Removable Media to a BES Cyber Asset.

As a method to detect malicious code, entities may choose to use Removable Media with on-board malicious code detection tools. For these tools, the Removable Media are still used in conjunction with a Cyber Asset to perform the detection. For Section 5.3.1, the Cyber Asset used to perform the malicious code detection must be outside of the BES Cyber System.

Requirement R3:

The intent of CIP-003-7, Requirement R3 is effectively unchanged since prior versions of the standard. The specific description of the CIP Senior Manager has now been included as a defined term rather than clarified in the Reliability Standard itself to prevent any unnecessary cross-reference to this standard. It is expected that the CIP Senior Manager will play a key role in ensuring proper strategic planning, executive/board-level awareness, and overall program governance.

Requirement R4:

As indicated in the rationale for CIP-003-7, Requirement R4, this requirement is intended to demonstrate a clear line of authority and ownership for security matters. The intent of the SDT was not to impose any particular organizational structure, but, rather, the intent is to afford the Responsible Entity significant flexibility to adapt this requirement to its existing organizational structure. A Responsible Entity may satisfy this requirement through a single delegation document or through multiple delegation documents. The Responsible Entity can make use of the delegation of the delegation authority itself to increase the flexibility in how this applies to its organization. In such a case, delegations may exist in numerous documentation records as long as the collection of these documentation records shows a clear line of authority back to the CIP Senior Manager. In addition, the CIP Senior Manager could also choose not to delegate any authority and meet this requirement without such delegation documentation.

The Responsible Entity must keep its documentation of the CIP Senior Manager and any delegations up-to-date. This is to ensure that individuals do not assume any undocumented authority. However, delegations do not have to be re-instated if the individual who delegated

the task changes roles or the individual is replaced. For instance, assume that John Doe is named the CIP Senior Manager and he delegates a specific task to the Substation Maintenance Manager. If John Doe is replaced as the CIP Senior Manager, the CIP Senior Manager documentation must be updated within the specified timeframe, but the existing delegation to the Substation Maintenance Manager remains in effect as approved by the previous CIP Senior Manager, John Doe.

Rationale:

During development of this standard, text boxes were embedded within the standard to explain the rationale for various parts of the standard. Upon BOT approval, the text from the rationale text boxes was moved to this section.

Rationale for Requirement R1:

One or more security policies enable effective implementation of the requirements of the cyber security Reliability Standards. The purpose of policies is to provide a management and governance foundation for all requirements that apply to a Responsible Entity's BES Cyber Systems. The Responsible Entity can demonstrate through its policies that its management supports the accountability and responsibility necessary for effective implementation of the requirements.

Annual review and approval of the cyber security policies ensures that the policies are kept-up-to-date and periodically reaffirms management's commitment to the protection of its BES Cyber Systems.

Rationale for Requirement R2:

In response to FERC Order No. 791, Requirement R2 requires entities to develop and implement cyber security plans to meet specific security control objectives for assets containing low impact BES Cyber System(s). The cyber security plan(s) covers four~~five~~ subject matter areas: (1) cyber security awareness; (2) physical security controls; (3) electronic access controls; ~~and~~ (4) Cyber Security Incident response; and (5) Transient Cyber Asset and Removable Media Malicious Code Risk Mitigation. This plan(s), along with the cyber security policies required under Requirement R1, Part 1.2, provides a framework for operational, procedural, and technical safeguards for low impact BES Cyber Systems.

Considering the varied types of low impact BES Cyber Systems across the BES, Attachment 1 provides Responsible Entities flexibility on how to apply the security controls to meet the security objectives. Additionally, because many Responsible Entities have multiple-impact rated BES Cyber Systems, nothing in the requirement prohibits entities from using their high and medium impact BES Cyber System policies, procedures, and processes to implement security controls required for low impact BES Cyber Systems, as detailed in Requirement R2, Attachment 1.

Responsible Entities will use their identified assets containing low impact BES Cyber System(s) (developed pursuant to CIP-002) to substantiate the sites or locations associated with low impact BES Cyber System(s). However, there is no requirement or compliance expectation for Responsible Entities to maintain a list(s) of individual low impact BES Cyber System(s) and their associated cyber assets or to maintain a list of authorized users.

Rationale for Requirement R3:

The identification and documentation of the single CIP Senior Manager ensures that there is clear authority and ownership for the CIP program within an organization, as called for in Blackout Report Recommendation 43. The language that identifies CIP Senior Manager responsibilities is included in the Glossary of Terms used in NERC Reliability Standards so that it may be used across the body of CIP standards without an explicit cross-reference.

FERC Order No. 706, Paragraph 296, requests consideration of whether the single senior manager should be a corporate officer or equivalent. As implicated through the defined term, the senior manager has "the overall authority and responsibility for leading and managing implementation of the requirements within this set of standards" which ensures that the senior manager is of sufficient position in the Responsible Entity to ensure that cyber security receives

the prominence that is necessary. In addition, given the range of business models for responsible entities, from municipal, cooperative, federal agencies, investor owned utilities, privately owned utilities, and everything in between, the SDT believes that requiring the CIP Senior Manager to be a “corporate officer or equivalent” would be extremely difficult to interpret and enforce on a consistent basis.

Rationale for Requirement R4:

The intent of the requirement is to ensure clear accountability within an organization for certain security matters. It also ensures that delegations are kept up-to-date and that individuals do not assume undocumented authority.

In FERC Order No. 706, Paragraphs 379 and 381, the Commission notes that Recommendation 43 of the 2003 Blackout Report calls for “clear lines of authority and ownership for security matters.” With this in mind, the Standard Drafting Team has sought to provide clarity in the requirement for delegations so that this line of authority is clear and apparent from the documented delegations.